



LI-TIAN LIGHTING

# LED LANDSCAPE & ARCHITECTURAL LIGHTING

## CERTIFICATION & SAFETY

LITIAN both as a company and for our products comply to all required international standards and certificates. LITIAN luminaires are designed and manufactured in accordance with international (IEC 60598 2-1) and European (EN 60598 2-1) standards. Internal electrical components are carefully selected from the world's leading manufacturers who have obtained safety and quality insignia such as; UL, ETL, VDE, IMQ, KEMA and ENEC.



### The protection classes and safety classes

Information on a luminaire withstanding the penetration of dust and water in accordance with IEC 60598 / VDE 0711.

#### SAFETY CLASSES



##### Safety class I

luminaire provided with an earth connection.



##### Safety class II

the functional insulation. The luminaire has an additional protective insulation. Under fault conditions there are no dangerous voltage can reach metal parts which can be touched.



##### Safety class III

luminaire supplied with low voltage (12V, 24V), the luminaire does not need to be earthed.

### Impact Resistance

The use of Joules (Newton metres-Nm) has been common for many years. More recently an IK rating normally used for electrical enclosures and cabinets (IEC 62262:2002) has emerged as manufacturers apply it to their luminaires, as they also enclose electrical circuits.

IK Rating	IK01	IK02	IK03	IK04	IK05	IK06	IK07	IK08	IK09	IK10
Joules of Energy	0.15j	0.23j	0.35j	0.5j	0.7j	1j	2j	5j	10j	20j

## Degree of protection

The Ingress Protection (IP) rating, or International Protection Code, classifies luminaires according to their protection against the ingress of dust, solid foreign bodies and water as an IP number system required by IEC 60529 and in accordance with IEC 60598.

## Energy efficiency of the lamps

Implementing Directive 2009/125/EC of the European Parliament and of the Council with regard to ecodesign requirements for directional lamps, light emitting diode lamps and related equipment. Following the regulations, the labelling information is shown in all the products with ICON of EEC classes in this website, catalogue, product spec sheets and the product manual.

## STANDARD

*la norme*

We manufacture lighting fixtures especially for outdoor applications together with general lamps and LED component technology according to International standards, European standard and U.S. Standard such as:

IEC 60598-1	EN 13032-1:2004/AC
IEC 60598-2-1	IES LM79-08 2008 IES
IEC 60598-2-2	LM80-08
IEC 60598-2-22	BS EN 40-2:2004 BS EN
IEC 60598-2-3	40-5:2002 BS EN
IEC 60598-2-5	40-6:2002 UL 1598
IEC 60598-2-6	ASTM B117
IEC 60598-2-13	CISPR 15
IEC 60598-2-18	



## LIGHT DISTRIBUTION

LITIAN provides a wide variety of optical light distributions suitable for all architectural, roadway and area lighting applications, for example, VN: very narrow, N: narrow beam, M: medium beam, W: wide beam, VW: very wide beam: E: elliptical beam, plus Type II, III, IV and ME classification from IESNA/EN.

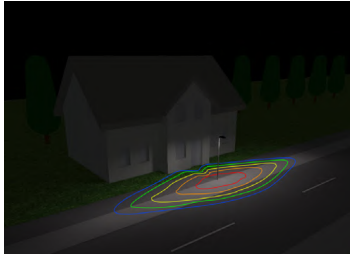

### Distribution Type I (T1)

Type I distributes a very lineal shape. It is the optimal choice for applications such as one or two-lane roadways, walkways, paths or sidewalks. With a preferred lateral width of 15 degrees, it is suitable for lighting streets or pathways that have a width of up to 2 times the mounting height.

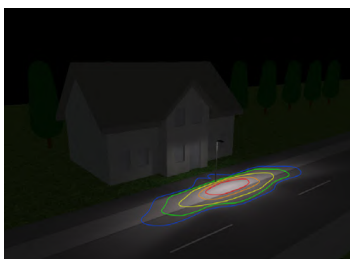

### Distribution Type II (T2)

Ideal for wider walkways, entrance, roadways, bike paths and other long and narrow lighting application. Intended to be located near the side of a roadway, approximately 1.15 MH. Half-maximum candela trace on the Street side is beyond the 1 MH LRL but not beyond the 1.75 MH LRL.



### Distribution Type III (T3)

Ideal for roadways, general parking, and other lighting application. Half-maximum candela trace on the Street side is beyond the 1.75 MH LRL but not beyond the 2.75 MH LRL.

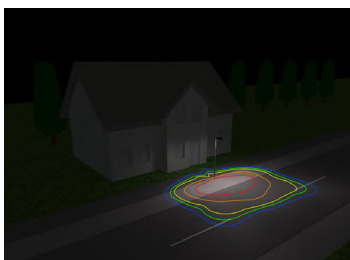

### Distribution Type IV (T4)

Especially suited for wall mounting or area applications and for illuminating the perimeter of parking areas. Half- maximum candela trace on the Street side is beyond the 2.75 MH LRLMH LRL.



### Distribution Type V (T5)

Type V distributes a circular pattern (there is also a Type VS that produces a square distribution with a more defined angle). Having the same distribution at all lateral angles, it is perfect for general area lighting—the ideal choice if you are looking to do parking lots or intersections.

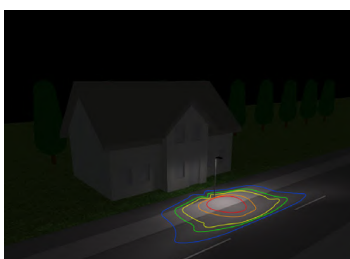

### Distribution Type ME

For motorized vehicles on traffic routes. Some countries apply ME classes from ME1-ME6, with ME1 defining the strictest requirements. For wet road conditions the MEW classes go from MEW1 to MEW6.

# PROJECTORS

FOR OUTDOOR PPLICATIONS

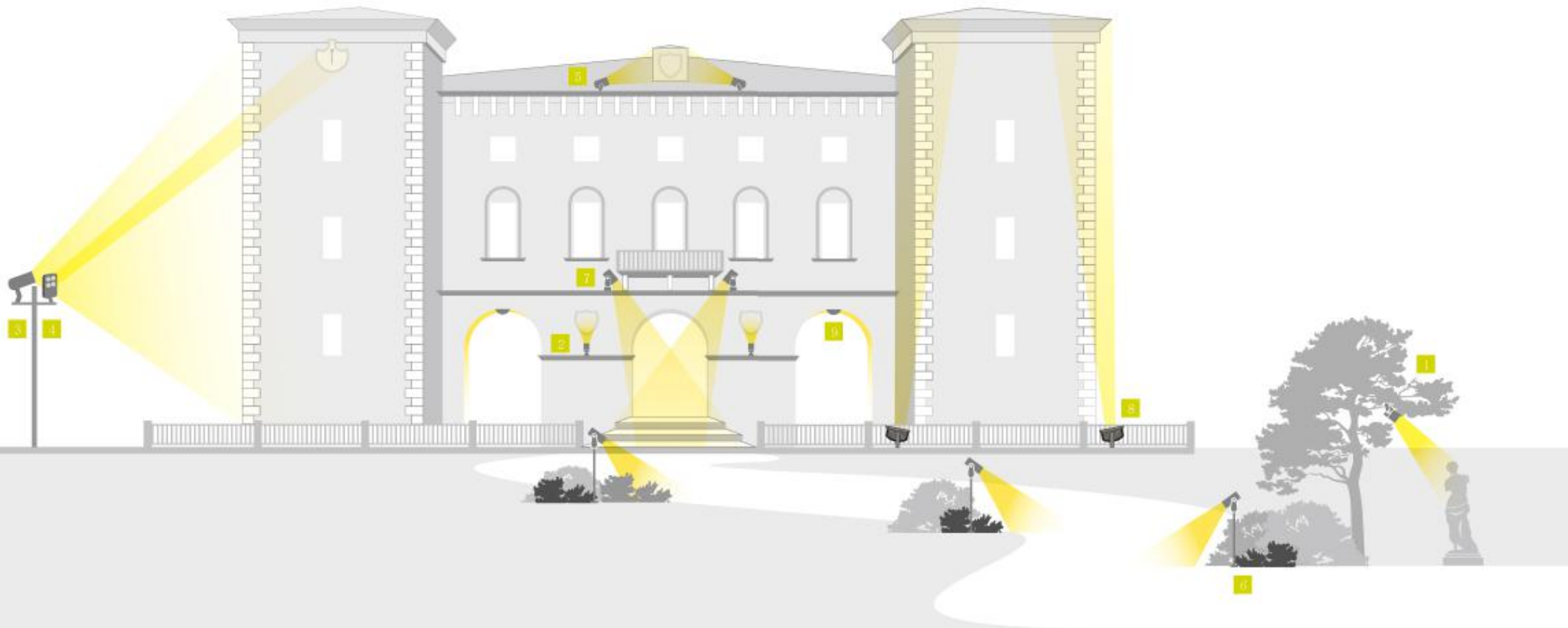

# Rose Series Projector



ROSE Pro



ROSE



ROSE Mini



LI-TIAN LIGHTING

Technical features



Technical data

Wattage	3/6/8W
IP Rating	IP66
IK Rating	IK06
Material	High corrosion resistance die-cast copper-free aluminum body
Coating	Polyester powder coating with phosphochromating pre-finish
Light source	1xCOB CRI>90
Standard Deviation Color Matching	:MacAdam step 3
Screws	Stainless steel
Transformer	Electronic power supply AC120-277V or DC12-24V
Gasket	Silicone rubber
Glass	Tempered
Power cable	0.5 mt. neoprene power cable included
Gross weight	0.35 Kg
Packaging size	41*21*41cm(20Pcs) 8.6kg

# ROSE Mini

## LT-SL 1.0

Whether lighting up a tree from below or hanging a fixture from it, to using a ground spike, pole clamp or yoke arm, there is a mounting solution to suit every application.

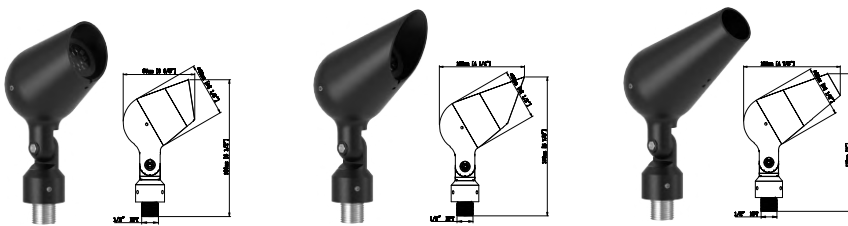
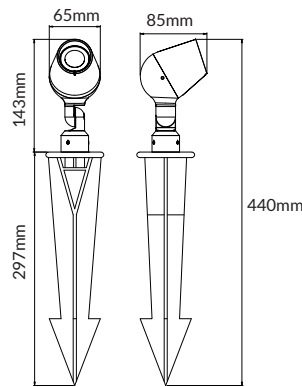

light source*	lumen output (lm)	lumin. efficacy (lm/w)	light beam options
3000°K warm-white			
3W COB	240.0	80.0	15°
6W COB	480.0		24°
8W COB	640.0		36°
			40*70°

2700/4000/5000K CCT available on request

Finish color options :



Customizable in different finishing colors

Option

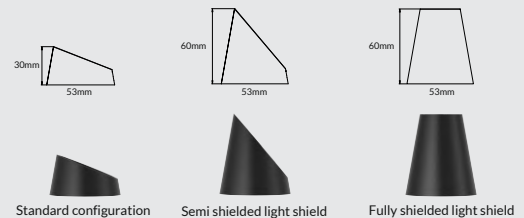

\*Different types of light shields can be replaced on site

OPTICAL ACCESSORIES

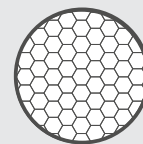

Honeycomb louvre built into the lighting fixture





LI-TIAN LIGHTING

Technical features



Technical data

Wattage	10/15/20W
IP Rating	IP66
IK Rating	IK06
Material	High corrosion resistance die-cast copper-free aluminum body
Coating	Polyester powder coating with phosphochromating pre-finish
Light source	1xCOB CRI>90
Standard Deviation Color Matching	:MacAdam step 3
Screws	Stainless steel
Transformer	Electronic power supply 220/240V 50/60Hz built-in or(AC120-277V)/(DC12-24V)
Gasket	Silicone rubber
Glass	Tempered
Power cable	0.5 mt. neoprene power cable included
Gross weight	1.1 Kg
Packaging size	33*27*31cm(6Pcs) 6.5kg



# ROSE

## LT-SL 2.0

Whether lighting up a tree from below or hanging a fixture from it, to using a ground spike, pole clamp or yoke arm, there is a mounting solution to suit every application.



light source*	lumen output (lm)	lumin. efficacy (lm/w)	light beam options
3000°K warm-white			
10W COB	960.0	96.00	15°
15W COB	1440.0		24°
20W COB	1920.0		36°
			60°
			40*70°

2700/4000/5000K CCT available on request

Finish color options :

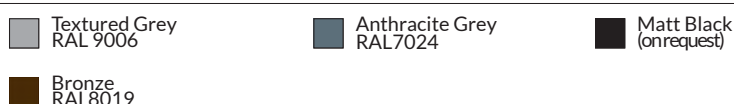

Customizable in different finishing colors

### OPTICAL ACCESSORIES

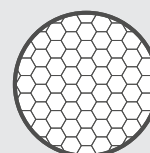

Honeycomb louvre built into the lighting fixture

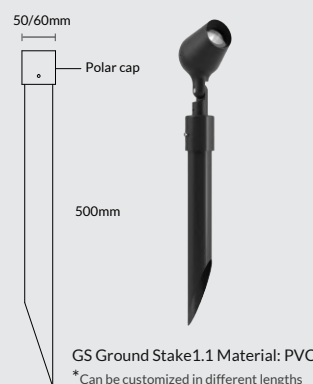



**NEW**



**LI-TIAN LIGHTING**

**Technical features**



**Technical data**

Wattage	10/15/20W
IP Rating	IP66
IK Rating	IK06
Material	High corrosion resistance die-cast copper-free aluminum body
Coating	Polyester powder coating with phosphochromating pre-finish
Light source	1xCOB CRI>90
Standard Deviation Color Matching	:MacAdam step 3
Screws	Stainless steel
Transformer	Electronic power supply 220/240V 50/60Hz built-in or(AC120-277V)/(DC12-24V)
Gasket	Silicone rubber
Glass	Tempered
Power cable	0.5 mt. neoprene power cable included
Gross weight	1.1 Kg
Packaging size	33*27*31cm(6Pcs) 6.5kg

**ROSE**  
**LT-SL 2.0+**

Whether lighting up a tree from below or hanging a fixture from it, to using a ground spike, pole clamp or yoke arm, there is a mounting solution to suit every application.

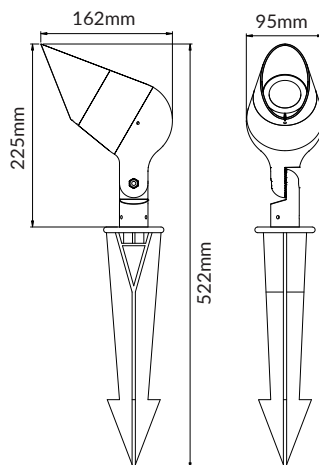

**OPTICAL ACCESSORIES**

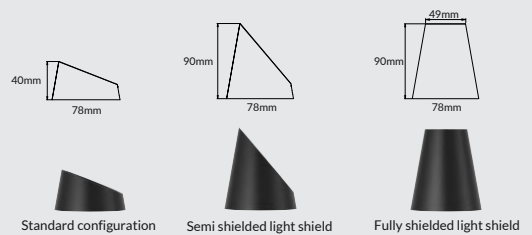

\* Different types of light shields can be replaced on site

light source*	lumen output (lm)	lumin. efficacy (lm/w)	light beam options
<b>3000°K warm-white</b>			
10W COB	960.0	96.00	15°
15W COB	1440.0		24°
20W COB	1920.0		36°
			60°
			40*70°

2700/4000/5000K CCT available on request

**Finish color options :**

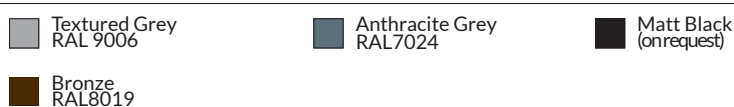

Customizable in different finishing colors

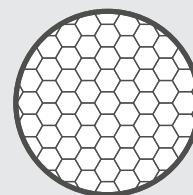

Honeycomb louvre built into the lighting fixture





LI-TIAN LIGHTING

Technical features



Technical data

Wattage	30/40/60W
IP Rating	IP66
IK Rating	IK06
Material	High corrosion resistance die-cast copper-free aluminum body
Coating	Polyester powder coating with phosphochromating pre-finish
Light source	1xCOB CRI>90
Standard Deviation Color Matching	:MacAdam step 3
Screws	Stainless steel
Transformer	Electronic power supply 220/240V 50/60Hz built-in or AC120-277V
Gasket	Silicone rubber
Glass	Tempered
Power cable	0.5 mt. neoprene power cable included
Gross weight	2.15 Kg
Packaging size	32*32*42cm 4PCS 8.6kg



# ROSE Pro

## LT-SL 3.0

Whether lighting up a tree from below or hanging a fixture from it, to using a ground spike, pole clamp or yoke arm, there is a mounting solution to suit every application.

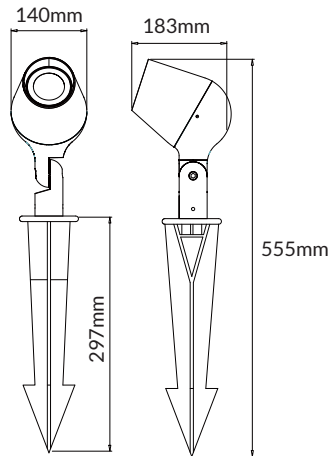

light source*	lumen output (lm)	lumin. efficacy (lm/w)	light beam options
<b>3000°K warm-white</b>			
30W COB	3000.0	100.00	15°
40W COB	4000.0		24°
60W COB	6000.0		36°
			40*70°

2700/4000/5000K CCT available on request

Finish color options :



Customizable in different finishing colors

OPTICAL ACCESSORIES

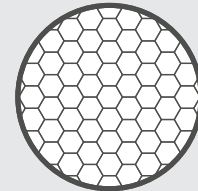

Honeycomb louvre built into the lighting fixture

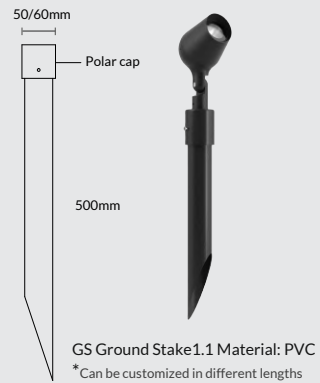

GS Ground Stake 1.1 Material: PVC  
\*Can be customized in different lengths





LI-TIAN LIGHTING

Technical features



Technical data

Wattage	3/6/8W
IP Rating	IP66
IK Rating	IK06
Material	High corrosion resistance die-cast copper-free aluminum body
Coating	Polyester powder coating with phosphochromating pre-finish
Light source	1xCOB CRI>90
Standard Deviation Color Matching	:MacAdam step 3
Screws	Stainless steel
Transformer	Electronic power supply AC120-277V or DC12-24V
Gasket	Silicone rubber
Glass	Tempered
Power cable	0.5 mt. neoprene power cable included
Gross weight	0.35 Kg
Packaging size	41*21*41cm(20Pcs) 8.6kg

# ROSE Mini

## LT-SL 1.1

Whether lighting up a tree from below or hanging a fixture from it, to using a ground spike, pole clamp or yoke arm, there is a mounting solution to suit every application.

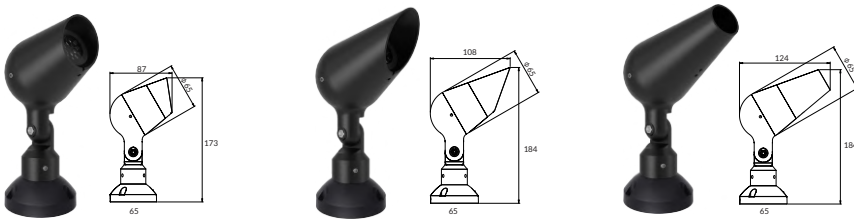

light source*	lumen output (lm)	lumin. efficacy (lm/w)	light beam options
3000°K warm-white			
3W COB	240.0	80.0	15°
6W COB	480.0		24°
8W COB	640.0		36°
			40*70°

2700/4000/5000K CCT available on request

Finish color options :

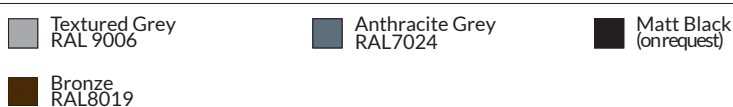

Customizable in different finishing colors

Option

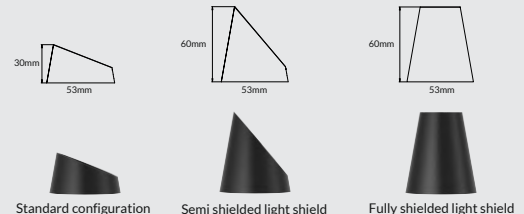

\*Different types of light shields can be replaced on site

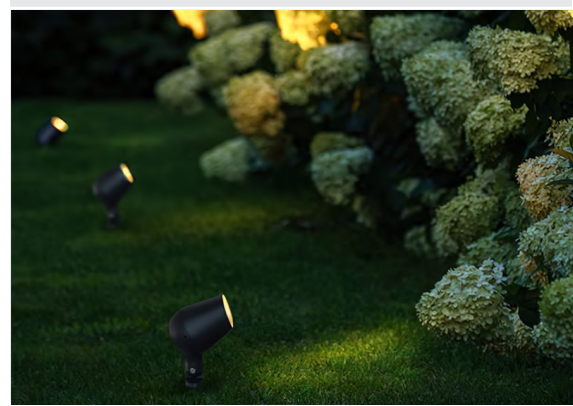
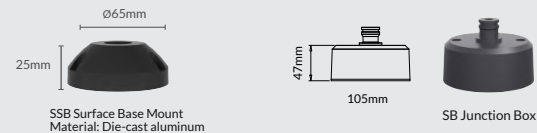



LI-TIAN LIGHTING

Technical features



Technical data

Wattage	10/15/20W
IP Rating	IP66
IK Rating	IK06
Material	High corrosion resistance die-cast copper-free aluminum body
Coating	Polyester powder coating with phosphochromating pre-finish
Light source	1xCOB CRI>90
Standard Deviation Color Matching	:MacAdam step 3
Screws	Stainless steel
Transformer	Electronic power supply 220/240V 50/60Hz built-in or(AC120-277V)/(DC12-24V)
Gasket	Silicone rubber
Glass	Tempered
Power cable	0.5 mt. neoprene power cable included
Gross weight	1.2 Kg
Packaging size	33*27*31cm(6Pcs) 6.5kg



# ROSE

## LT-SL2.1

Whether lighting up a tree from below or hanging a fixture from it, to using a ground spike, pole clamp or yoke arm, there is a mounting solution to suit every application.

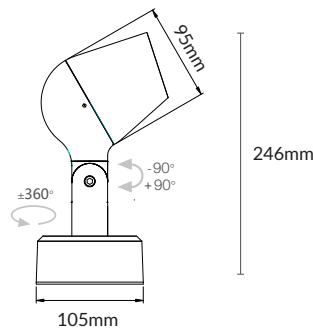

### OPTICAL ACCESSORIES

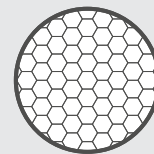

Honeycomb louvre built into the lighting fixture

### OPTION

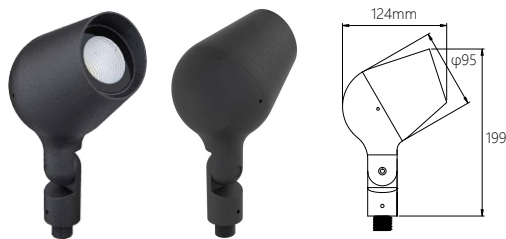
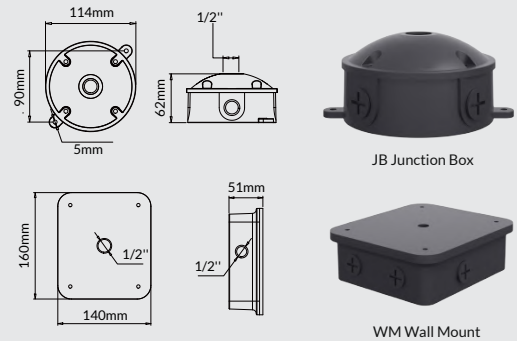

light source*	lumen output (lm)	lumin. efficacy (lm/w)	light beam options
3000°K warm-white			
10W COB	960.0	96.00	15°
15W COB	1440.0		24°
20W COB	1920.0		36°
			60°
			40*70°

2700/4000/5000K CCT available on request

### Finish color options :

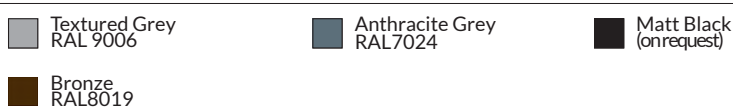

Customizable in different finishing colors



**NEW**



# ROSE

## LT-SL2.1+

Whether lighting up a tree from below or hanging a fixture from it, to using a ground spike, pole clamp or yoke arm, there is a mounting solution to suit every application.

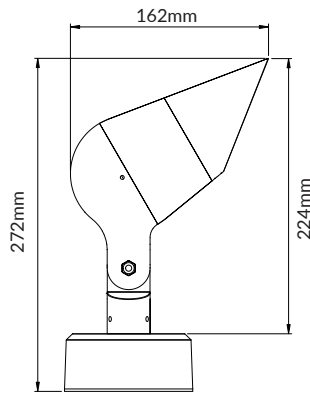

light source*	lumen output (lm)	lumin. efficacy (lm/w)	light beam options
<b>3000°K warm-white</b>			
10W COB	960.0	96.00	15°
15W COB	1440.0		24°
20W COB	1920.0		36°
			60°
			40*70°

2700/4000/5000K CCT available on request

**Finish color options :**

- Textured Grey RAL 9006
- Anthracite Grey RAL7024
- Matt Black (onrequest)
- Bronze RAL8019

Customizable in different finishing colors



**LI-TIAN LIGHTING**

**Technical features**



**Technical data**

Wattage	10/15/20W
IP Rating	IP66
IK Rating	IK06
Material	High corrosion resistance die-cast copper-free aluminum body
Coating	Polyester powder coating with phosphochromating pre-finish
Light source	1xCOB CRI>90
Standard Deviation Color Matching	:MacAdam step 3
Screws	Stainless steel
Transformer	Electronic power supply 220/240V 50/60Hz built-in or(AC120-277V)/(DC12-24V)
Gasket	Silicone rubber
Glass	Tempered
Power cable	0.5 mt. neoprene power cable included
Gross weight	1.2 Kg
Packaging size	33*27*31cm(6Pcs) 6.5kg

**OPTION**

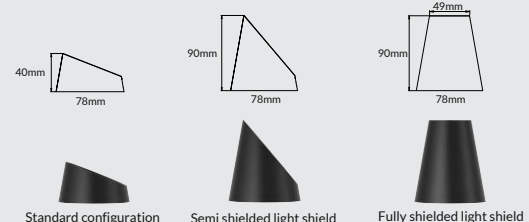

\* Different types of light shields can be replaced on site

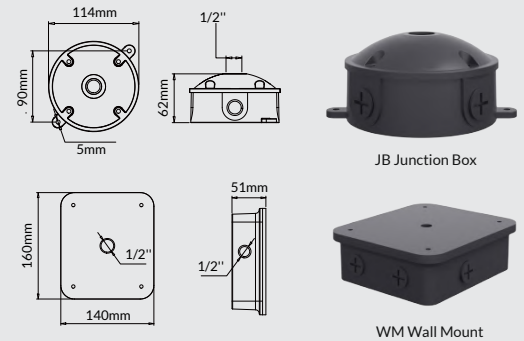



LI-TIAN LIGHTING

Technical features



Technical data

Wattage	30/40/60W
IP Rating	IP66
IK Rating	IK06
Material	High corrosion resistance die-cast copper-free aluminum body
Coating	Polyester powder coating with phosphochromating pre-finish
Light source	1xCOB CRI>90
Standard Deviation Color Matching	:MacAdam step 3
Screws	Stainless steel
Transformer	Electronic power supply 220/240V 50/60Hz built-in or AC120-277V
Gasket	Silicone rubber
Glass	Tempered
POWER CABLES	Neoprene cable 3x0.75
Power cable	0.5 mt. neoprene power cable included
Gross weight	2.15 Kg
Packaging size	32*32*42cm 4PCS 8.6kg



# ROSE Pro

## LT-SL3.1

Whether lighting up a tree from below or hanging a fixture from it, to using a ground spike, pole clamp or yoke arm, there is a mounting solution to suit every application.

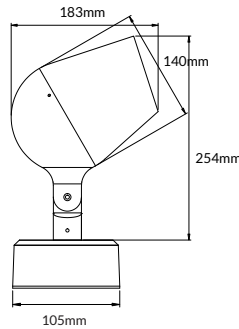

light source*	lumen output (lm)	lumin. efficacy (lm/w)	light beam options
<b>3000°K warm-white</b>			
30W COB	3000.0	100.00	15°
40W COB	4000.0		24°
60W COB	6000.0		36°
			40*70°

2700/4000/5000K CCT available on request

Finish color options :

- Textured Grey RAL 9006
- Anthracite Grey RAL7024
- Matt Black (onrequest)
- Bronze RAL8019

Customizable in different finishing colors

### OPTICAL ACCESSORIES

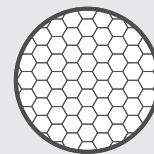

Honeycomb louvre built into the lighting fixture

### OPTION

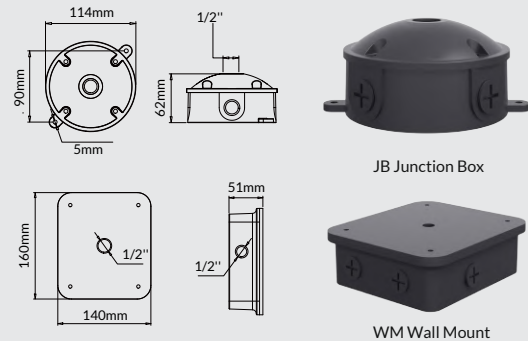



LI-TIAN LIGHTING

Technical features



Technical data

Wattage	12W
IP Rating	IP66
IK Rating	IK06
Material	High corrosion resistance die-cast copper-free aluminum body
Coating	Polyester powder coating with phosphochromating pre-finish
Light source	1xCOB CRI>80
Standard Deviation Color Matching	:MacAdam step 3
Screws	Stainless steel
Transformer	Silicone rubber
Gasket	Electronic power supply DC 24V
Wireless transmission distance	:30m
Power cable	0.5 mt. neoprene power cable included
Gross weight	1.2 Kg
Packaging size	33*27*31cm(6Pcs) 6.5kg



# ROSE RGBW

## LT-SL 2.0-RGBW

Whether lighting up a tree from below or hanging a fixture from it, to using a ground spike, pole clamp or yoke arm, there is a mounting solution to suit every application.

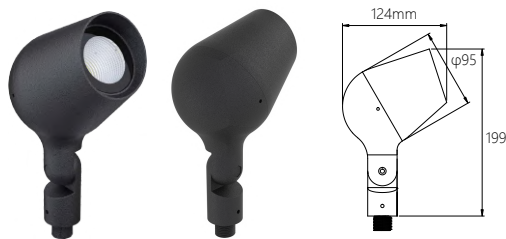

light source*	lumen output (lm)	lumin. efficacy (lm/w)	light beam options
RGBW			
12W COB	396.0	33.00	

OPTION

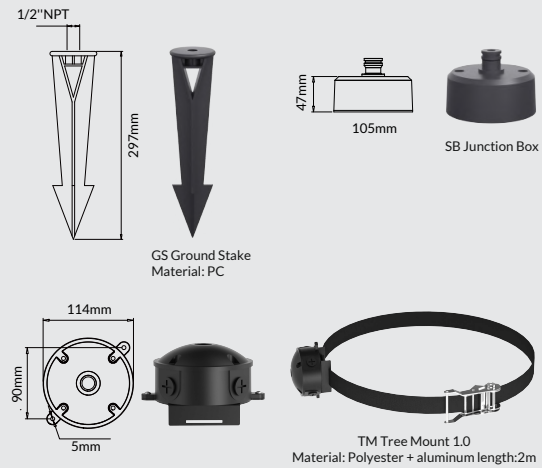

Finish color options :

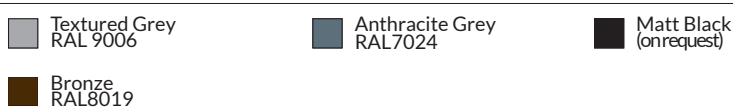

Customizable in different finishing colors



LI-TIAN LIGHTING

Technical features



DMX512

Technical data

Wattage	12W
IP Rating	IP66
IK Rating	IK06
Material	High corrosion resistance die-cast copper-free aluminum body
Coating	Polyester powder coating with phosphochromating pre-finish
Light source	3x 3535LED CRI>80
Standard Deviation Color Matching	:MacAdam step 3
Screws	Stainless steel
Transformer	Silicone rubber
Gasket	Electronic power supply DC 24V
Power cable	0.5 mt. neoprene power cable included
Gross weight	1.2 Kg
Packaging size	33*27*31cm(6Pcs) 6.5kg



# ROSE RGBW

## LT-SL2.0-RGBW-512

Whether lighting up a tree from below or hanging a fixture from it, to using a ground spike, pole clamp or yoke arm, there is a mounting solution to suit every application.

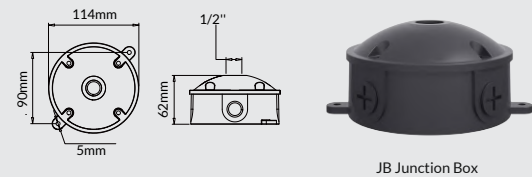
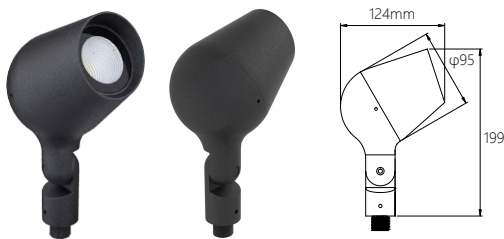

light source*	lumen output (lm)	lumin. efficacy (lm/w)	light beam options
RGBW			
12W	396.0	33.00	

Finish color options :

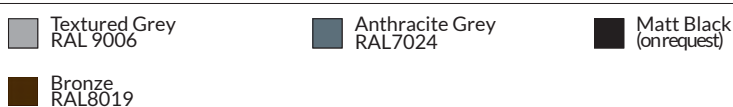

Customizable in different finishing colors







LI-TIAN LIGHTING

Technical features



DMX512

Technical data

Wattage	24/36W
IP Rating	IP66
IK Rating	IK06
Material	High corrosion resistance die-cast copper-free aluminum body
Coating	Polyester powder coating with phosphochromating pre-finish
Light source	8x 3535LED CRI>80
Standard Deviation Color Matching	:MacAdam step 3
Screws	Stainless steel
Transformer	Silicone rubber
Gasket	Electronic power supply DC 24V
Power Cables	Neoprene cable 5x0.75
Power cable	0.5 mt. neoprene power cable included
Gross weight	2.15 Kg
Packaging size	32*32*42cm 4PCS 8.2Kg



# ROSE Pro RGBW

## LT-SL3.0-RGBW-512

Whether lighting up a tree from below or hanging a fixture from it, to using a ground spike, pole clamp or yoke arm, there is a mounting solution to suit every application.

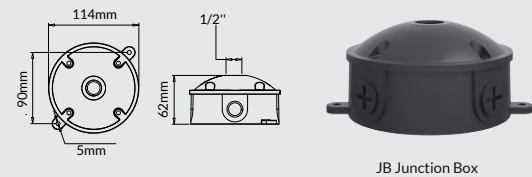

light source*	lumen output (lm)	lumin. efficacy (lm/w)	light beam options
RGBW			
24W	792.0	33.00	15°
			24°
			36°
36W	1188.0		60°
			40*70°

Finish color options :

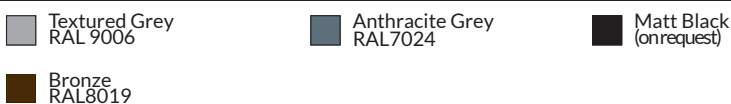

Customizable in different finishing colors





LI-TIAN LIGHTING

Technical features



Technical data

Wattage	3/6/8W
IP Rating	IP66
IK Rating	IK06
Material	High corrosion resistance die-cast copper-free aluminum body
Coating	Polyester powder coating with phosphochromating pre-finish
Light source	1 x COB CRI>90
Standard Deviation Color Matching	:MacAdam step 3
Screws	Stainless steel
Transformer	Electronic power supply AC120-277V or DC12-24V
Gasket	Silicone rubber
Glass	Tempered
Power cable	0.5 mt. neoprene power cable included

# ROSE Mini

## LT-SL 1.2

Whether lighting up a tree from below or hanging a fixture from it, to using a ground spike, pole clamp or yoke arm, there is a mounting solution to suit every application.

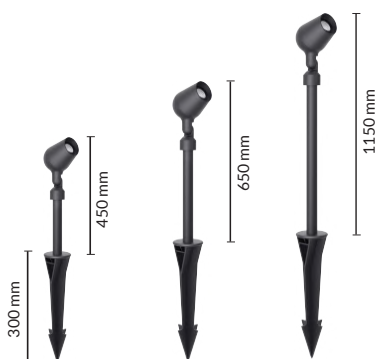

- φ25mm Extension arm 300 mm**  
Extension pipe length 300 mm made in anodized aluminum.
- φ25mm Extension arm 500 mm**  
Extension pipe length 600 mm made in anodized aluminum.
- φ25mm Extension arm 1000 mm**  
Extension pipe length 1000 mm made in anodized aluminum.

Option

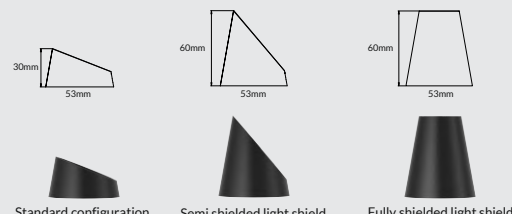

\*Different types of light shields can be replaced on site

light source*	lumen output (lm)	lumin. efficacy (lm/w)	light beam options
3000°K warm-white			
3W COB	240.0	80.0	15°
6W COB	480.0		24°
8W COB	640.0		36°
			40*70°

2700/4000/5000K CCT available on request

Finish color options :

- Textured Grey RAL 9006
- Anthracite Grey RAL7024
- Matt Black (onrequest)
- Bronze RAL8019

Customizable in different finishing colors

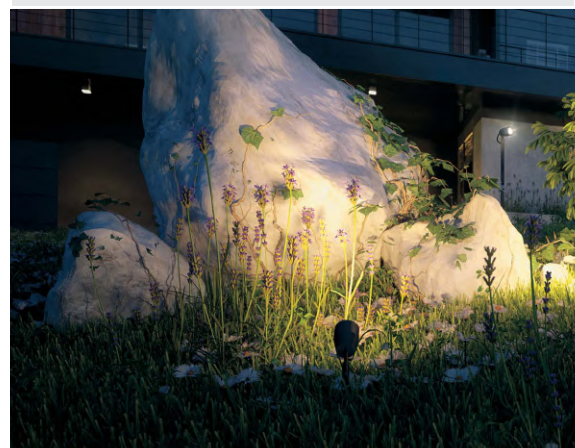
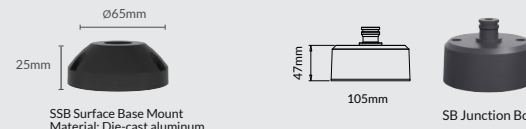



LI-TIAN LIGHTING

Technical features



Technical data

Wattage	10/15/20W
IP Rating	IP66
IK Rating	IK06
Material	High corrosion resistance die-cast copper-free aluminum body
Coating	Polyester powder coating with phosphochromating pre-finish
Light source	1xCOB CRI>90
Standard Deviation Color Matching	:MacAdam step 3
Screws	Stainless steel
Transformer	Electronic power supply 220/240V 50/60Hz built-in or(AC120-277V)/(DC12-24V)
Gasket	Silicone rubber
Glass	Tempered
Power Cables	Neoprene cable 3x0.75
Power cable	0.5 mt. neoprene power cable included
Gross weight	1.2 Kg
Packaging size	33*27*31cm(6Pcs) 6.5kg



# ROSE

## LT-SL2.2

Whether lighting up a tree from below or hanging a fixture from it, to using a ground spike, pole clamp or yoke arm, there is a mounting solution to suit every application.

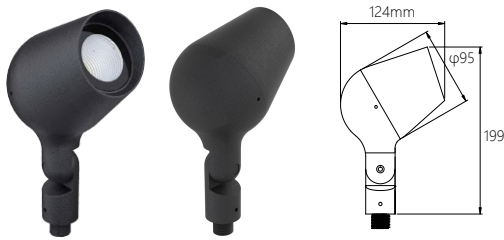
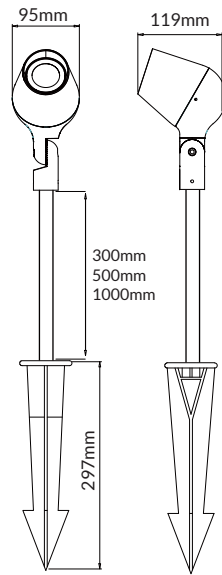

light source*	lumen output (lm)	lumin. efficacy (lm/w)	light beam options
3000°K warm-white			
10W COB	960.0	96.00	15°
15W COB	1440.0		24°
20W COB	1920.0		36°
			60°
			40*70°

2700/4000/5000K CCT available on request

Finish color options :

- Textured Grey RAL 9006
- Anthracite Grey RAL7024
- Matt Black (onrequest)
- Bronze RAL8019

Customizable in different finishing colors

**φ25mm** Extension arm 300 mm  
Extension pipe length 300 mm made in anodized aluminum.

**φ25mm** Extension arm 500 mm  
Extension pipe length 600 mm made in anodized aluminum.

**φ25mm** Extension arm 1000 mm  
Extension pipe length 900 mm made in anodized aluminum.



OPTION

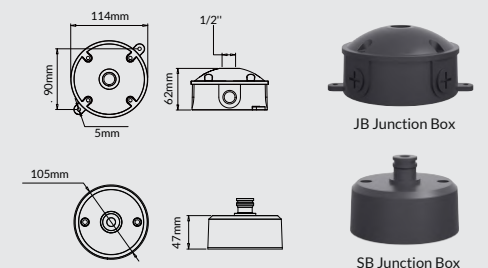



LI-TIAN LIGHTING

Technical features



Technical data

Wattage	30/40/60W
IP Rating	IP66
IK Rating	IK06
Material	High corrosion resistance die-cast copper-free aluminum body
Coating	Polyester powder coating with phosphochromating pre-finish
Light source	1xCOB CRI>90
Standard Deviation Color Matching	:MacAdam step 3
Screws	Stainless steel
Transformer	Electronic power supply 220/240V 50/60Hz built-in or AC120-277V
Gasket	Silicone rubber
Glass	Tempered
Power cable	0.5 mt. neoprene power cable included
Gross weight	2.15 Kg
Packaging size	32*32*42cm 4PCS 8.6kg

φ25mm Extension arm 300 mm  
Extension pipe length 300 mm made in anodized aluminum.

φ25mm Extension arm 500 mm  
Extension pipe length 600 mm made in anodized aluminum.

φ25mm Extension arm 1000 mm  
Extension pipe length 1000 mm made in anodized aluminum.

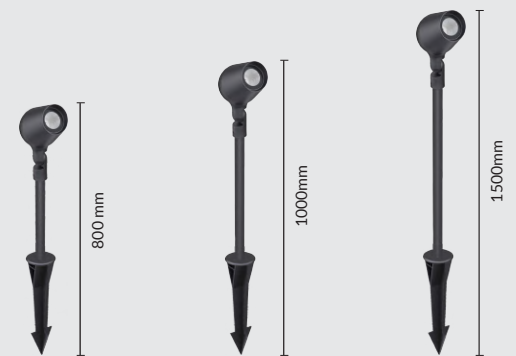

OPTION

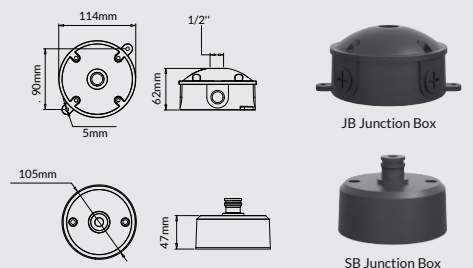

# ROSE Pro

## LT-SL3.2

Whether lighting up a tree from below or hanging a fixture from it, to using a ground spike, pole clamp or yoke arm, there is a mounting solution to suit every application.

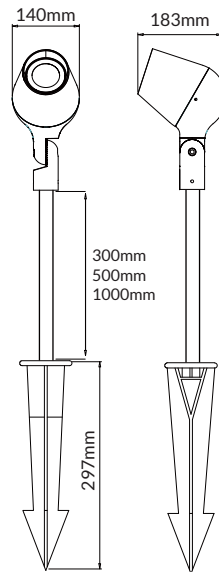

light source*	lumen output (lm)	lumin. efficacy (lm/w)	light beam options
3000°K warm-white			
30W COB	3000.0	100.00	15°
40W COB	4000.0		24°
60W COB	6000.0		36°
			60°
			40°*70°

2700/4000/5000K CCT available on request

Finish color options :

- Textured Grey RAL 9006
- Anthracite Grey RAL7024
- Matt Black (onrequest)
- Bronze RAL8019

Customizable in different finishing colors



LI-TIAN LIGHTING

Technical features



Technical data

Wattage	3/6/8W
IP Rating	IP66
IK Rating	IK06
Material	High corrosion resistance die-cast copper-free aluminum body
Coating	Polyester powder coating with phosphochromating pre-finish
Light source	1 x COB CRI>90
Standard Deviation Color Matching	:MacAdam step 3
Screws	Stainless steel
Transformer	Electronic power supply AC120-277V or DC12-24V
Gasket	Silicone rubber
Glass	Tempered
Power cable	0.5 mt. neoprene power cable included
Gross weight	0.35 Kg
Packaging size	41*21*41cm(20pcs) 8.6kg



# ROSE Mini

## LT-SL 1.3

Whether lighting up a tree from below or hanging a fixture from it, to using a ground spike, pole clamp or yoke arm, there is a mounting solution to suit every application.

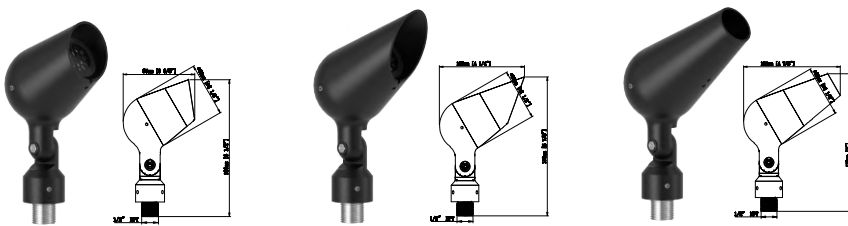

light source*	lumen output (lm)	lumin. efficacy (lm/w)	light beam options
3000°K warm-white			
3W COB	240.0	80.0	15°
6W COB	480.0		24°
8W COB	640.0		36°
			40°70°

2700/4000/5000K CCT available on request

Option

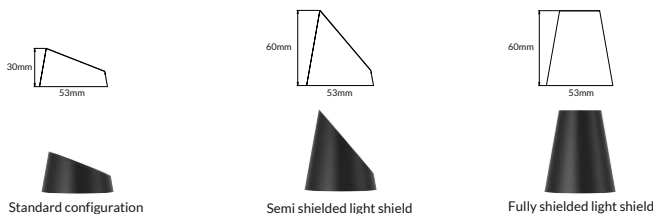

OPTION

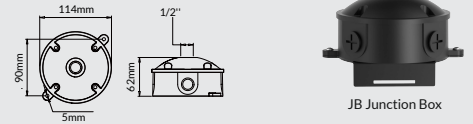

JB Junction Box

TM Tree Mount 1.0  
Material: Polyester + aluminum length:2m

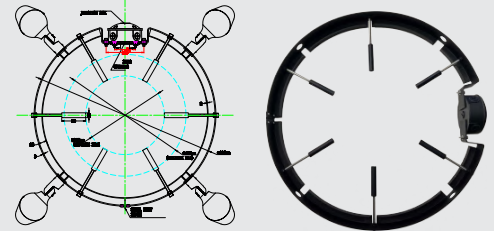

TM Tree Mount 2.0  
Material: 304 stainless steel ring + die-casting aluminum waterproof box





LI-TIAN LIGHTING

Technical features



Technical data

Wattage	10/15/20W
IP Rating	IP66
IK Rating	IK06
Material	High corrosion resistance die-cast copper-free aluminum body
Coating	Polyester powder coating with phosphochromating pre-finish
Light source	1xCOB CRI>90
Standard Deviation Color Matching	:MacAdam step 3
Screws	Stainless steel
Transformer	Electronic power supply 220/240V 50/60Hz built-in or(AC120-277V)/(DC12-24V)
Gasket	Silicone rubber
Glass	Tempered
Power cable	0.5 mt. neoprene power cable included
Gross weight	1.2 Kg
Packaging size	33*27*31cm(6Pcs) 6.5kg



Tree Ring Installation

# ROSE

## LT-SL2.3

Whether lighting up a tree from below or hanging a fixture from it, to using a ground spike, pole clamp or yoke arm, there is a mounting solution to suit every application.



light source*	lumen output (lm)	lumin. efficacy (lm/w)	light beam options
3000°K warm-white			
10W COB	960.0	96.00	15°
15W COB	1440.0		24°
20W COB	1920.0		36°
			40°70°

2700/4000/5000K CCT available on request

Finish color options :



Customizable in different finishing colors

\*Different tree ring sizes can be customized according to needs

OPTION

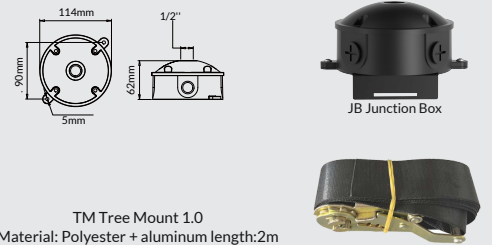

TM Tree Mount 1.0  
Material: Polyester + aluminum length:2m

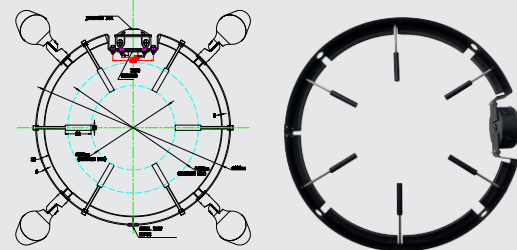

TM Tree Mount 2.0  
Material: 304 stainless steel ring + die-casting aluminum waterproof box

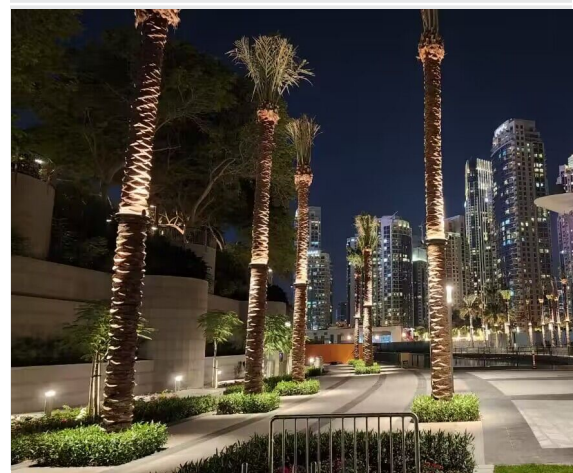



LI-TIAN LIGHTING

Technical features



Technical data

Wattage	30/40/60W
IP Rating	IP66
IK Rating	IK06
Material	High corrosion resistance die-cast copper-free aluminum body
Coating	Polyester powder coating with phosphochromating pre-finish
Light source	1xCOB CRI>90
Standard Deviation Color Matching	:MacAdam step 3
Screws	Stainless steel
Transformer	Electronic power supply 220/240V 50/60Hz built-in or AC120-277V
Gasket	Silicone rubber
Glass	Tempered
Power cable	0.5 mt. neoprene power cable included
Gross weight	2.15 Kg
Packaging size	32*32*42cm 4PCS 8.6kg



Tree Ring Installation

# ROSE Pro

## LT-SL3.3

Whether lighting up a tree from below or hanging a fixture from it, to using a ground spike, pole clamp or yoke arm, there is a mounting solution to suit every application.



light source*	lumen output (lm)	lumin. efficacy (lm/w)	light beam options
3000°K warm-white			
30W COB	3000.0	100.00	15°
40W COB	4000.0		24°
60W COB	6000.0		36°
			40°*70°

2700/4000/5000K CCT available on request

Finish color options :

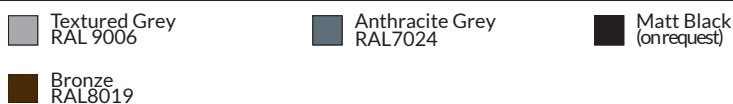

Customizable in different finishing colors

\*Different tree ring sizes can be customized according to needs

OPTION

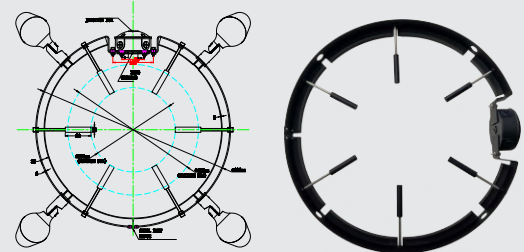
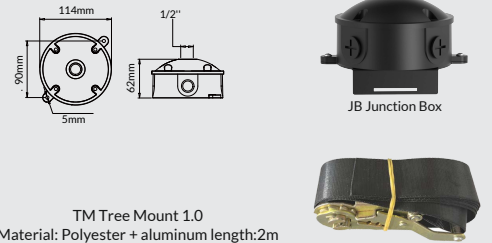

TM Tree Mount 2.0  
Material: 304 stainless steel ring + die-casting aluminum waterproof box





LI-TIAN LIGHTING

Technical features



Technical data

Wattage	10/15/20W
IP Rating	IP66
IK Rating	IK06
Material	High corrosion resistance die-cast copper-free aluminum body
Coating	Polyester powder coating with phosphochromating pre-finish
Light source	1xCOB CRI>90
Standard Deviation Color Matching	:MacAdam step 3
Screws	Stainless steel
Transformer	Electronic power supply 220/240V 50/60Hz built-in or(AC120-277V)/(DC12-24V)
Gasket	Silicone rubber
Glass	Tempered
Power cable	0.5 mt. neoprene power cable included
Gross weight	1.2 Kg
Packaging size	33*27*31cm(6Pcs) 6.5kg



# ROSE

## LT-SL2.4

Luminaire Suitable For Pole Mounting In Single Or Multiple Combinations

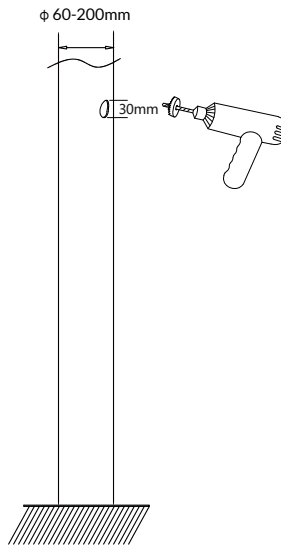

### Coupler

Suitable to be used with poles diam. min 60 mm and diam. max 200 mm. Can be positioned on various staggered levels or on a single level, with the same pole. Made in phospho chromatised and polyester powder coated dia-cast copper-free aluminum material.

light source*	lumen output (lm)	lumin. efficacy (lm/w)	light beam options
<b>3000°K warm-white</b>			
10W COB	960.0	96.00	15°
15W COB	1440.0		24°
20W COB	1920.0		36°
			60°
			40°70°

2700/4000/5000K CCT available on request

### Finish color options :

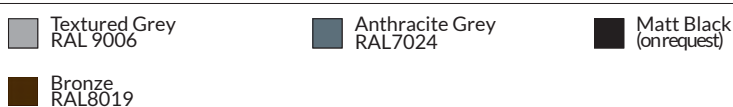

Customizable in different finishing colors

\*Can be drilled on-site, φ 30mm, flexible combination.

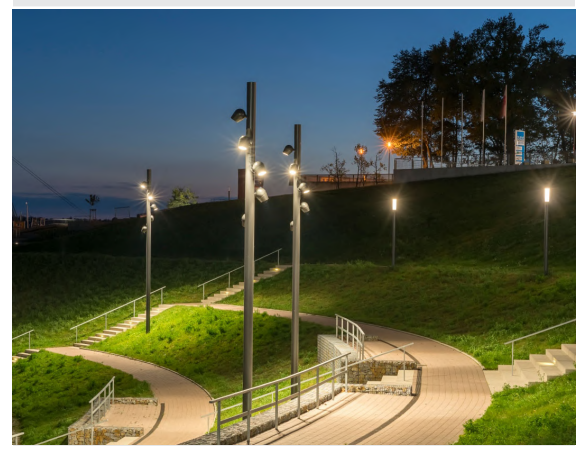





LI-TIAN LIGHTING

Technical features



Technical data

Wattage	30/40/60W
IP Rating	IP66
IK Rating	IK06
Material	High corrosion resistance die-cast copper-free aluminum body
Coating	Polyester powder coating with phosphochromating pre-finish
Light source	1xCOB CRI>90
Screws	Stainless steel
Transformer	Electronic power supply 220/240V 50/60Hz built-in or AC120-277V
Gasket	Silicone rubber
Glass	Tempered
Power cable	0.5 mt. neoprene power cable included
Gross weight	2.15 Kg
Packaging size	32*32*42cm 4PCS 8.6kg



# ROSE Pro

## LT-SL3.4

Luminaire Suitable For Pole Mounting In Single Or Multiple Combinations

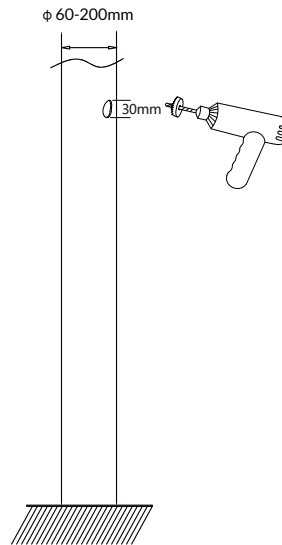

Coupler

Suitable to be used with poles diam. min 60 mm and diam. max 200 mm. Can be positioned on various staggered levels or on a single level, with the same pole. Made in phospho chromatised and polyester powder coated dia-cast copper-free aluminum material.

light source*	lumen output (lm)	lumin. efficacy (lm/w)	light beam options
<b>3000°K warm-white</b>			
30W COB	3000.0	100.00	15°
40W COB	4000.0		24°
60W COB	6000.0		36°
			40*70°

2700/4000/5000K CCT available on request

Finish color options :



Customizable in different finishing colors

\*Can be drilled on-site, φ 30mm, flexible combination.





LI-TIAN LIGHTING

Technical features



Technical data

Wattage	10/15/20W
IP Rating	IP66
IK Rating	IK06
Material	High corrosion resistance die-cast copper-free aluminum body
Coating	Polyester powder coating with phosphochromating pre-finish
Light source	1xCOB CRI>90
Screws	Stainless steel
Transformer	Electronic power supply 220/240V 50/60Hz built-in or(AC120-277V)/(DC12-24V)
Gasket	Silicone rubber
Glass	Tempered
Power cable	0.5 mt. neoprene power cable included
Gross weight	1.2 Kg
Packaging size	33*27*31cm(6Pcs) 6.5kg

# ROSE

## LT-SL2.5

Overhead installation



Option

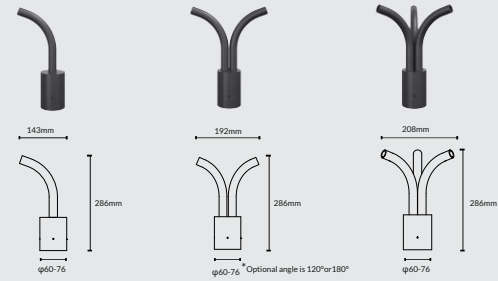

Candlestick

Material: steel  
Suitable for φ60-76mm pole

light source*	lumen output (lm)	lumin. efficacy (lm/w)	light beam options
3000°K warm-white			
10W COB	960.0	96.00	15°
			24°
15W COB	1440.0		36°
20W COB	1920.0		40°70°

2700/4000/5000K CCT available on request

Finish color options :

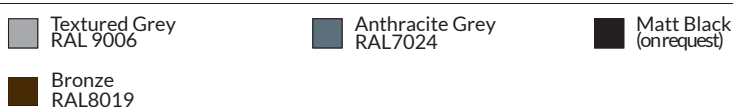

Customizable in different finishing colors





LI-TIAN LIGHTING

Technical features



Technical data

Wattage	30/40/60W
IP Rating	IP66
IK Rating	IK06
Material	High corrosion resistance die-cast copper-free aluminum body
Coating	Polyester powder coating with phosphochromating pre-finish
Light source	1xCOB CRI>90
Screws	Stainless steel
Transformer	Electronic power supply 220/240V 50/60Hz built-in or AC120-277V
Gasket	Silicone rubber
Glass	Tempered
Power cable	0.5 mt. neoprene power cable included
Gross weight	2.15 Kg
Packaging size	32*32*42cm 4PCS 8.6kg



# ROSE Pro

## LT-SL3.5

Overhead installation



Option

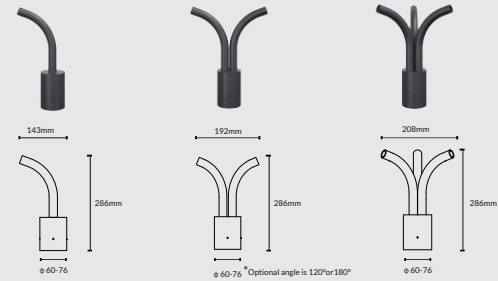

**Candlestick**  
Material: steel  
Suitable for φ60-76mm pole

light source*	lumen output (lm)	lumin. efficacy (lm/w)	light beam options
<b>3000°K warm-white</b>			
30W COB	3000.0	100.00	15°
40W COB	4000.0		24°
60W COB	6000.0		36°
			40°/70°

2700/4000/5000K CCT available on request

Finish color options :

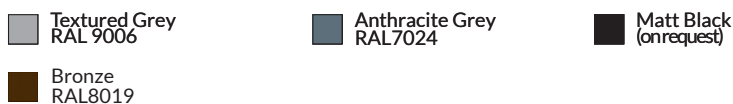

Customizable in different finishing colors





LI-TIAN LIGHTING

Technical features



Technical data

Wattage	30/40/60W
IP Rating	IP66
IK Rating	IK06
Material	High corrosion resistance die-cast copper-free aluminum body
Coating	Polyester powder coating with phosphochromating pre-finish
Light source	1xCOB CRI>90
Screws	Stainless steel
Transformer	Electronic power supply 220/240V 50/60Hz built-in or(AC120-277V)/(DC12-24V)
Gasket	Silicone rubber
Glass	Tempered
Power cable	0.5 mt. neoprene power cable included
Gross weight	2.15 Kg
Packaging size	32*32*42cm 4PCS 8.6kg

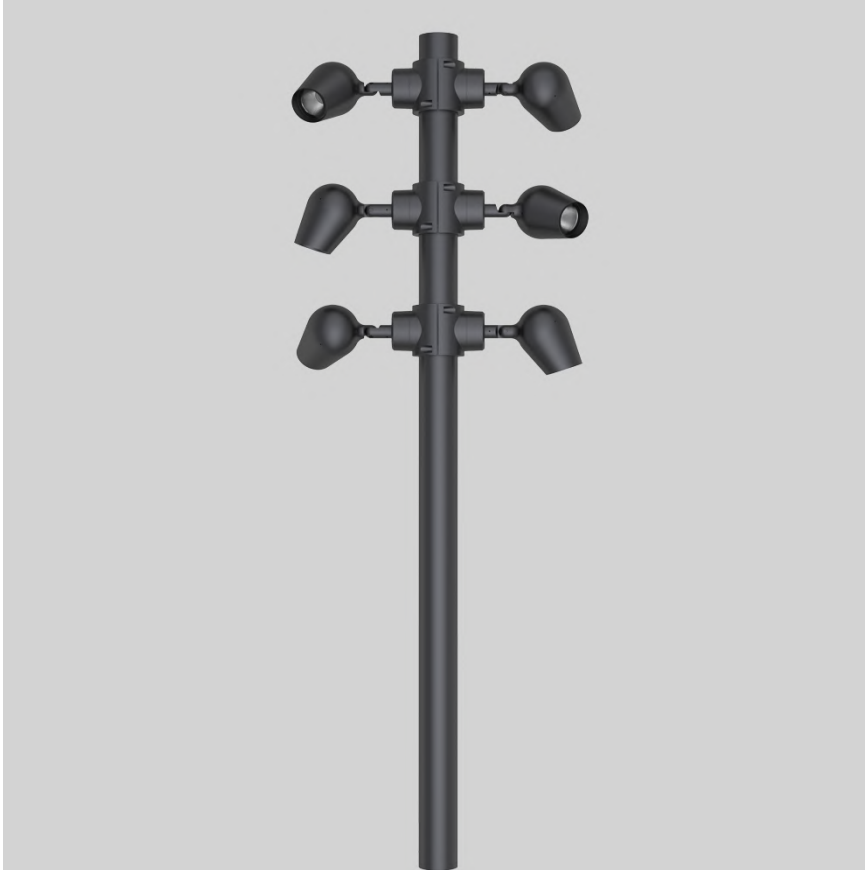

# ROSE Pro

## LT-SL3.6

Flange installation

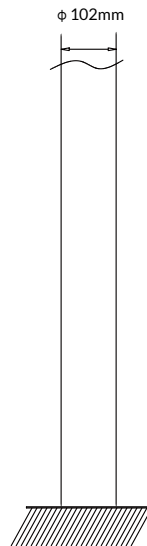

Option



Unilateral flange  
Material: Die cast aluminum



Bilateral flange



light source*	lumen output (lm)	lumin. efficacy (lm/w)	light beam options
3000°K warm-white			
30W COB	3000.0	100.00	15°
40W COB	4000.0		24°
60W COB	6000.0		36°
			40°70°

2700/4000/5000K CCT available on request

Finish color options :



Customizable in different finishing colors





LI-TIAN LIGHTING

Technical features



Technical data

Wattage	30/40/60W
IP Rating	IP66
IK Rating	IK06
Material	High corrosion resistance die-cast copper-free aluminum body
Coating	Polyester powder coating with phosphochromating pre-finish
Light source	1xCOB CRI>90
Screws	Stainless steel
Transformer	Electronic power supply 220/240V 50/60Hz built-in or(AC120-277V)/(DC12-24V)
Gasket	Silicone rubber
Glass	Tempered
Power cable	0.5 mt. neoprene power cable included
Gross weight	2.15 Kg
Packaging size	32*32*42cm 4PCS 8.6kg

# ROSE Pro

## LT-SL3.7

Flange(bracket) installation

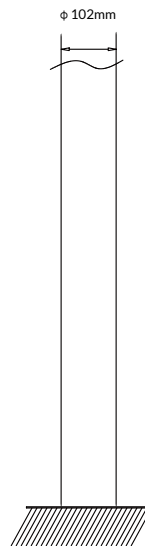
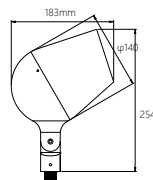

Option



Material: Die cast aluminum/aluminum profile

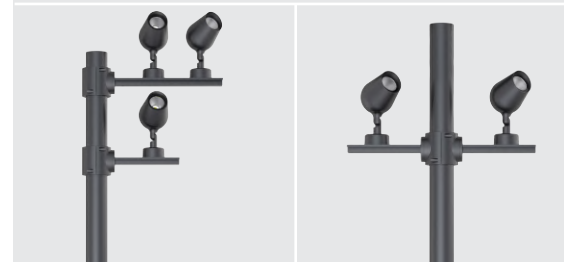

light source*	lumen output (lm)	lumin. efficacy (lm/w)	light beam options
3000°K warm-white			
30W COB	3000.0	100.00	15°
40W COB	4000.0		24°
60W COB	6000.0		36°
			40°70°

2700/4000/5000K CCT available on request

Finish color options :

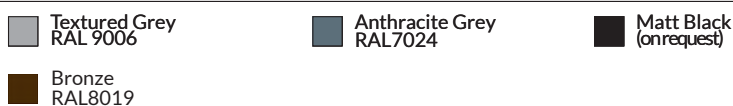

Customizable in different finishing colors



**NEW**



**LI-TIAN LIGHTING**

**Technical features**



**Technical data**

Wattage	30/40/60W
IP Rating	IP66
IK Rating	IK06
Material	High corrosion resistance die-cast copper-free aluminum body
Coating	Polyester powder coating with phosphochromating pre-finish
Light source	1xCOB CRI>90
Screws	Stainless steel
Transformer	Electronic power supply 220/240V 50/60Hz built-in or(AC120-277V)/(DC12-24V)
Gasket	Silicone rubber
Glass	Tempered
Power cable	0.5 mt. neoprene power cable included
Gross weight	2.15 Kg
Packaging size	32*32*42cm 4PCS 8.6kg

# ROSE Pro

LT-SL3.8

Kingfisher/Installing Lamp Arm



**Option**

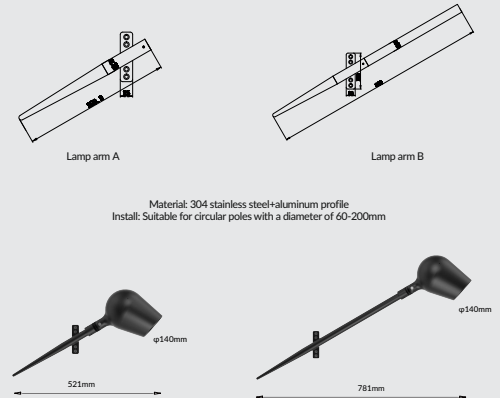

light source*	lumen output (lm)	lumin. efficacy (lm/w)	light beam options
<b>3000°K warm-white</b>			
30W COB	3000.0	100.00	15°
40W COB	4000.0		24°
60W COB	6000.0		36°
			40°70°

2700/4000/5000K CCT available on request

**Finish color options :**

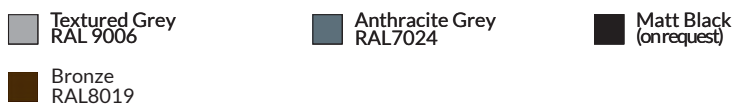

Customizable in different finishing colors





LI-TIAN LIGHTING

Technical features



Technical data

Wattage	10/15/20W
IP Rating	IP66
IK Rating	IK06
Material	High corrosion resistance die-cast copper-free aluminum body
Coating	Polyester powder coating with phosphochromating pre-finish
Light source	1xCOB CRI>90
Screws	Stainless steel
Transformer	Electronic power supply 220/240V 50/60Hz built-in or(AC120-277V)/(DC12-24V)
Gasket	Silicone rubber
Glass	Tempered
Power cable	0.5 mt. neoprene power cable included
Gross weight	1.2 Kg
Packaging size	33*27*31cm(6Pcs) 6.5kg



ROSE LT-SL2.6

Sign Light

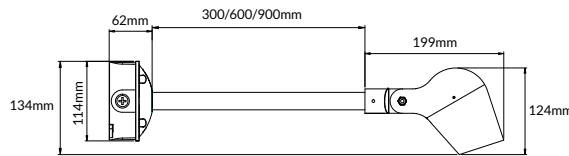

OPTION

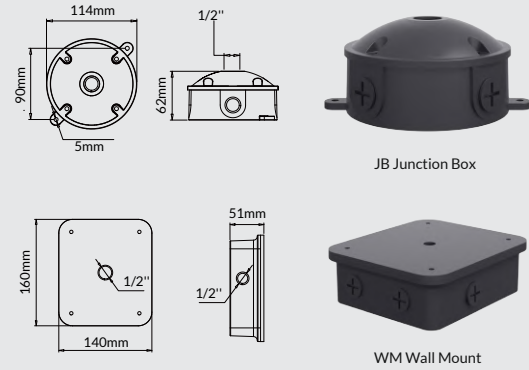

light source*	lumen output (lm)	lumin. efficacy (lm/w)	light beam options
3000°K warm-white			
10W COB	960.0	96.00	15°
15W COB	1440.0		24°
20W COB	1920.0		36°
			40°70°

2700/4000/5000K CCT available on request

Finish color options :

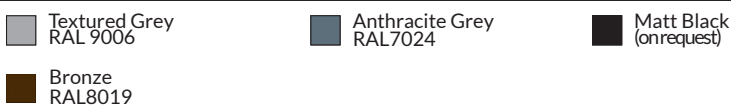

Customizable in different finishing colors

Extension arm  
Material: Aluminum profile  
Specification: Thickness 4mm, φ 25mm  
\*Length can be customized



# BOLLARDS AND URBAN LIGHTING

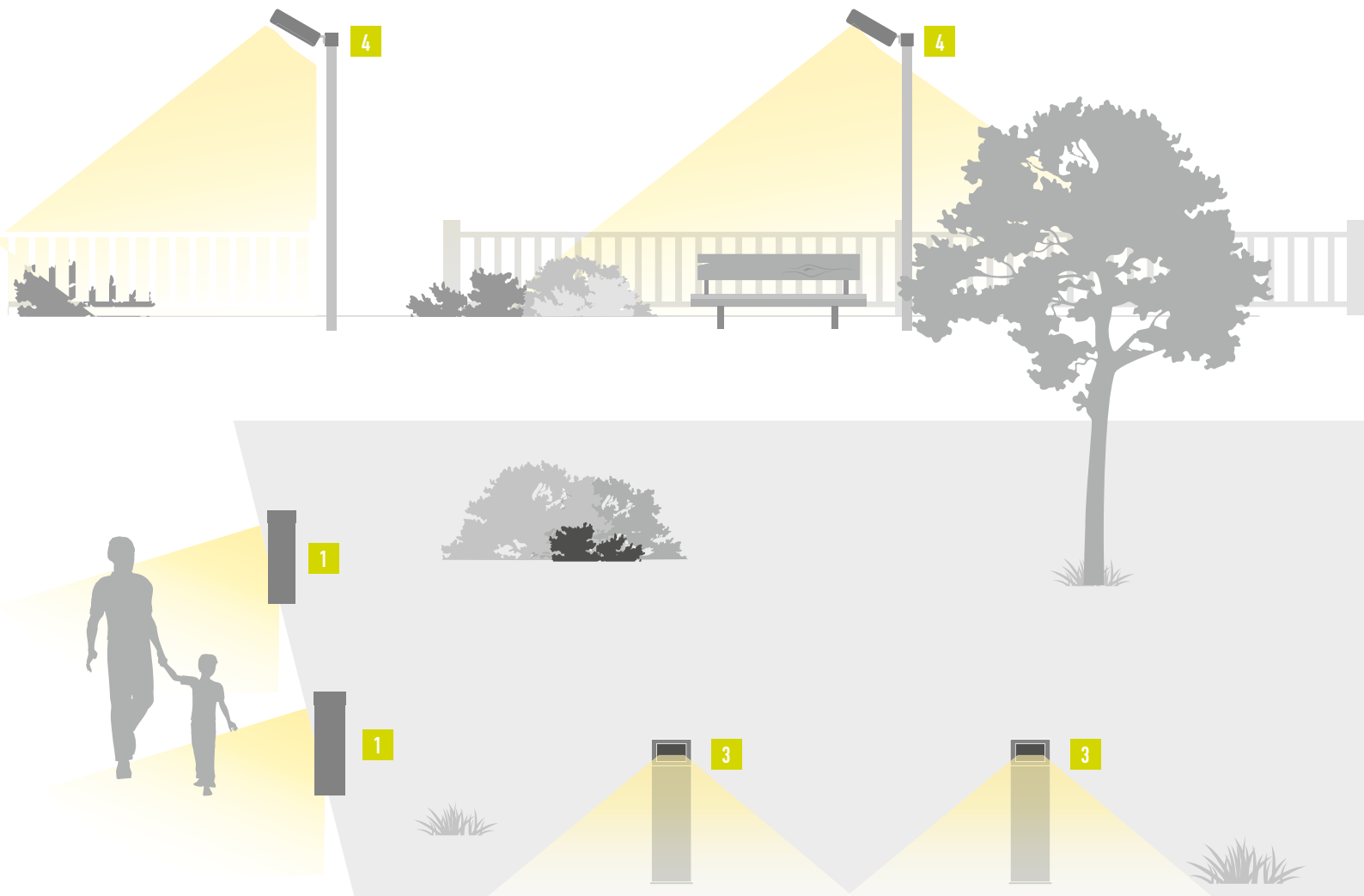





LI-TIAN LIGHTING

Technical features



Technical data

Wattage	100/150/200W
IP Rating	IP65
IK Rating	IK06
Material	High corrosion resistance die-cast copper-free aluminum body
Coating	Polyester powder coating with phosphochromating pre-finish
Light source	144/200/288 x 3030LED CRI>80
Standard Deviation Color Matching :MacAdam step 3	
Screws	Stainless steel
Transformer	Electronic power supply 220/240V 50/60Hz built-in or AC120-277V
Gasket	Silicone rubber
Glass	Tempered
Power cable	0.5 mt. neoprene power cable included
Gross weight	5.5 Kg



# LT-OK

The LTOK LED area/site luminaire delivers exceptional performance in a scalable, low-profile design. The precision engineered optics provide uniform illumination to walkways, parking lots, roadways, building areas and security lighting applications. Backed by a five-year limited warranty, the LTOK LED area/site luminaire is the LED answer to your area and site lighting needs.

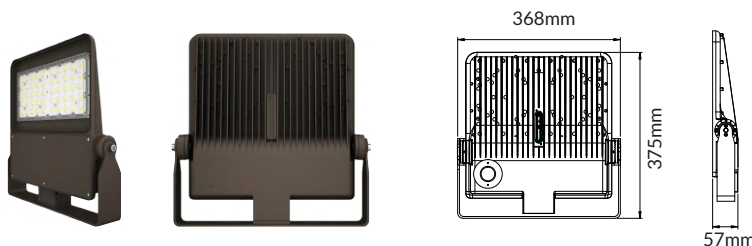

light source*	lumen output (lm)	lumin. efficacy (lm/w)	light beam options
5000°K white			
LT-OK-100W	14000.0	140.0	Symmetry 135°
LT-OK-150W	21000.0		Asymmetric TYPE III(73x149°)
LT-OK-200W	28000.0		Asymmetric TYPE IV(86x153°)

3000/4000K CCT available on request

Finish color options :



Customizable in different finishing colors

Option

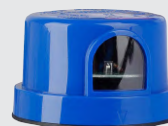

Photocell

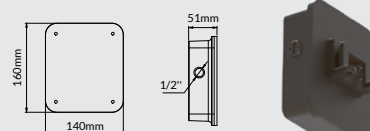
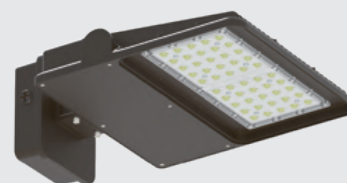

Wall Mount





LI-TIAN LIGHTING

Technical features



Technical data

Wattage	300W
IP Rating	IP65
IK Rating	IK06
Material	High corrosion resistance die-cast copper-free aluminum body
Coating	Polyester powder coating with phosphochromating pre-finish
Light source	464 x 3030LED CRI>80
Standard Deviation Color Matching	:MacAdam step 3
Screws	Stainless steel
Transformer	Electronic power supply 220/240V 50/60Hz built-in or AC120-277V
Gasket	Silicone rubber
Glass	Tempered
Power cable	0.5 mt. neoprene power cable included
Gross weight	8.4Kg

# LT-OK

The LTOK LED area/site luminaire delivers exceptional performance in a scalable, low-profile design. The precision engineered optics provide uniform illumination to walkways, parking lots, roadways, building areas and security lighting applications. Backed by a five-year limited warranty, the LTOK LED area/site luminaire is the LED answer to your area and site lighting needs.

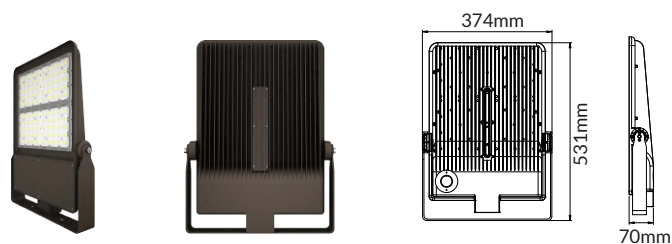

light source*	lumen output (lm)	lumin. efficacy (lm/w)	light beam options
5000°K white			Symmetry 135°
LT-OK-300W	42000.0	140.0	Asymmetric TYPE III(73x149°)
			Asymmetric TYPE IV(86x153°)

3000/4000K CCT available on request

Finish color options :

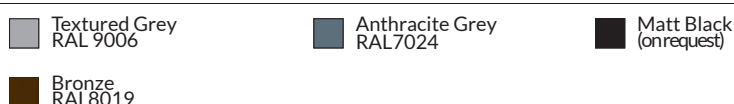

Customizable in different finishing colors

Option

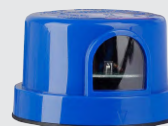

Photocell

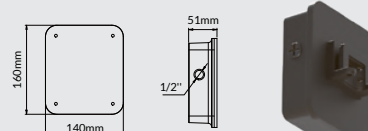
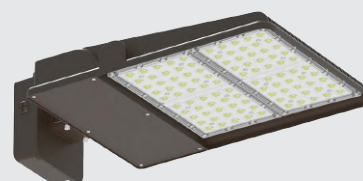

Wall Mount





LI-TIAN LIGHTING

Technical features



Technical data

Wattage	12W
IP Rating	IP65
IK Rating	IK08
Material	High corrosion resistance die-cast copper-free aluminum body +Aluminum profile
Coating	Polyester powder coating with phosphochromating pre-finish
Light source	4x5050LED CRI>80
Standard Deviation Color Matching	:MacAdam step 3
Screws	Stainless steel
Transformer	Electronic power supply 220/240V 50/60Hz built-in or AC120-277V/DC12-24V
Gasket	Silicone rubber
Glass	Tempered
Power cable	1 mt. neoprene power cable included
Gross weight	(0.6m)4.5 Kg (0.8m)5.5 Kg (1m)6.5 Kg
Package size	(0.6m)66*23*22cm (0.8m)86*23*22cm (1m)106*23*22cm



# LAUGH

## LT-BL

A series of LED light building elements with asymmetrical light distribution. Light building elements are luminous design features for public areas. They are ideally suited for delineating and structuring interior and exterior spaces such as landscape areas, plazas, building entrances

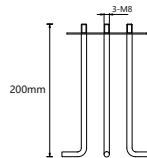
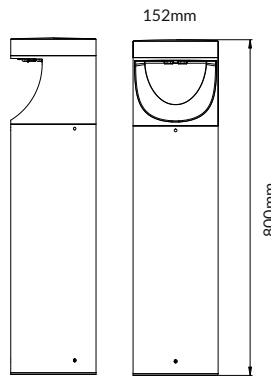

Concrete anchor 1023  
Material: steel  
\*Need to be purchased separately

light source*	lumen output (lm)	lumin. efficacy (lm/w)	light beam options
5000K white			
LT-BL-12W	960.0	80.0	Asymmetric (70x150°)

3000/4000K CCT available on request Unilateral light output

Finish color options :



Customizable in different finishing colors

IES DISTRIBUTIONS (OPTION)

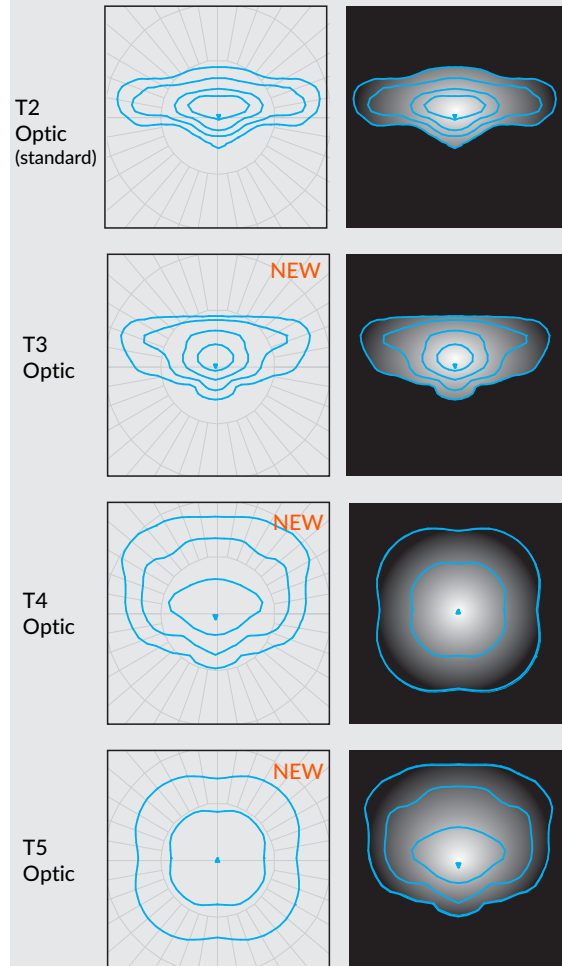



LI-TIAN LIGHTING

Technical features



Technical data

Wattage	24W
IP Rating	IP65
IK Rating	IK08
Material	High corrosion resistance die-cast copper-free aluminum body +Aluminum profile
Coating	Polyester powder coating with phosphochromating pre-finish
Light source	8x5050LED CRI>80
Standard Deviation Color Matching	:MacAdam step 3
Screws	Stainless steel
Transformer	Electronic power supply 220/240V 50/60Hz built-in or AC120-277V/DC12-24V
Gasket	Silicone rubber
Glass	Tempered
Power cable	1 mt. neoprene power cable included
Gross weight	(0.6m)4.5 Kg (0.8m)5.5 Kg (1m)6.5 Kg
Package size	(0.6m)66*23*22cm (0.8m)86*23*22cm (1m)106*23*22cm



# LAUGH

## LT-BL

A series of LED light building elements with asymmetrical light distribution. Light building elements are luminous design features for public areas. They are ideally suited for delineating and structuring interior and exterior spaces such as landscape areas, plazas, building entrances

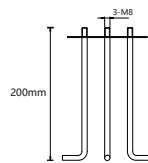
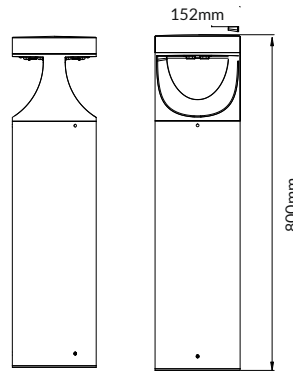

Concrete anchor 1023  
Material: steel  
\*Need to be purchased separately

light source*	lumen output (lm)	lumin. efficacy (lm/w)	light beam options
5000K white			
LT-BL-24W	1920.0	80.0	Asymmetric 2*(70x150°)

3000/4000K CCT available on request Bilateral light output

Finish color options :

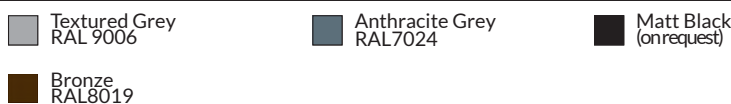

Customizable in different finishing colors

IES DISTRIBUTIONS (OPTION)

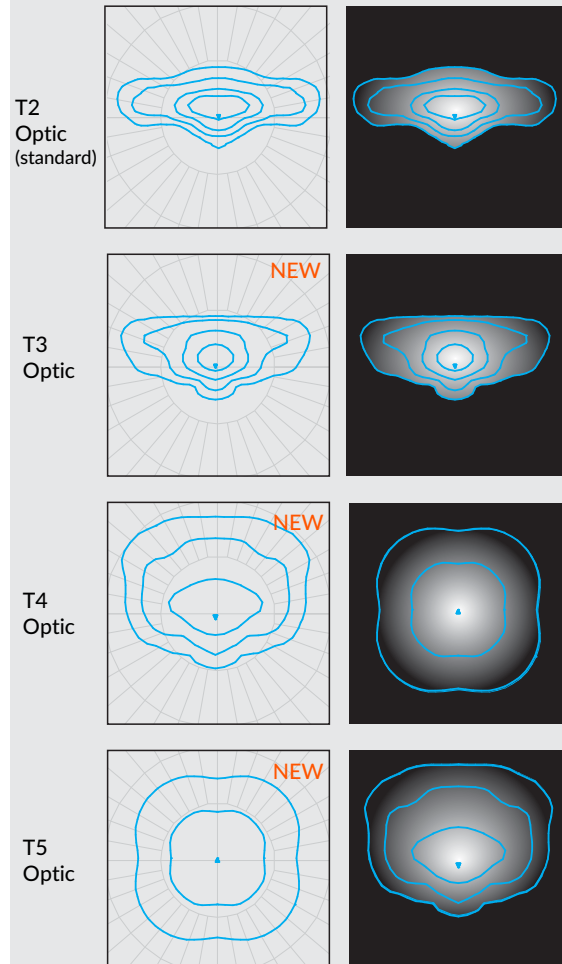



NEW



## Create biologically sustainable lighting with Amber lenses

Eliminate blue light and provide always warm colours with white light LEDs.

Us and those around us

We are constantly increasing our knowledge about what good lighting is and want to remain at the forefront in providing the best optical solutions to enhance well-being for both ourselves and the ecosystem around us. In urban environments illumination itself, or sudden changes to it, can influence how nocturnal fauna behave. Some species of both flora and fauna are especially sensitive to changes in brightness levels or light wavelengths, as they influence how they communicate, navigate, or reproduce. Many species are especially sensitive to the lower part (blue light) of the spectrum from 380 to 500 nanometres which should be avoided where possible

---

the data

---

## Conclusion

Amber lenses cut down the blue light spectrum from white light LEDs to provide safer lighting for night-time surroundings.

Compared to a typical 6000 lm park luminaire the savings in luminaire component cost with AMBER lenses is around half that of amber coloured LEDs with clear lenses. (To achieve the same lumen output only half as many LEDs and optics are needed). This results in a more compact luminaire design and less pressure on our environment.



LI-TIAN LIGHTING

Technical features

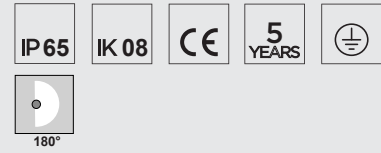

Technical data

Wattage	12W
IP Rating	IP65
IK Rating	IK08
Material	High corrosion resistance die-cast copper-free aluminum body +Aluminum profile
Coating	Polyester powder coating with phosphochromating pre-finish
Light source	18x2835LED CRI>80
Standard Deviation Color Matching	:MacAdam step 3
Screws	Stainless steel
Transformer	Electronic power supply 220/240V 50/60Hz built-in or AC120-277V/DC12-24V
Gasket	Silicone rubber
Glass	Tempered
Power cable	1 mt. neoprene power cable included
Gross weight	(0.6m)4.5 Kg (0.8m)5.5 Kg (1m)6.5 Kg
Package size	(0.6m)66*23*22cm (0.8m)86*23*22cm (1m)106*23*22cm



# ECLIPSE

## LT-YS

Super comfort, no glare at all  
 180° and 360° symmetrical light distribution  
 Die-cast aluminum fixture with polyester powder coating on the surface  
 IK08 IP65 protection level  
 Multiple installation options

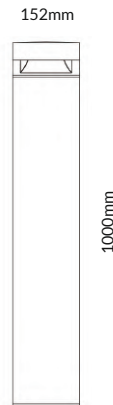

### Option

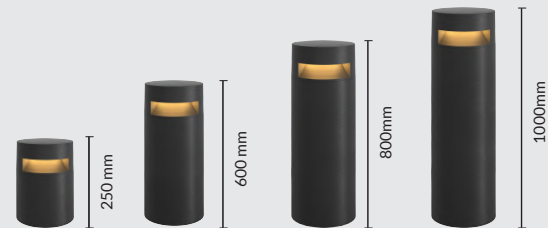

light source*	lumen output (lm)	lumin. efficacy (lm/w)	light beam options
5000K white			
LT-YS-12W	497.0	42.0	Symmetry 180°

3000/4000K CCT available on request

### Finish color options :

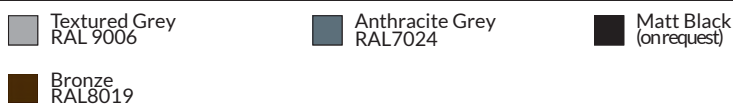

Customizable in different finishing colors

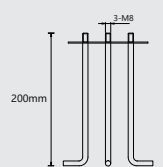

Concrete anchor 1023  
Material: steel  
\*Need to be purchased separately





LI-TIAN LIGHTING

### Technical features

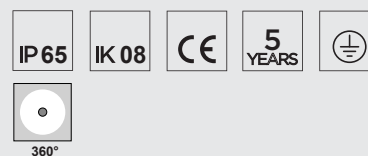

### Technical data

Wattage	24W
IP Rating	IP65
IK Rating	IK08
Material	High corrosion resistance die-cast copper-free aluminum body +Aluminum profile
Coating	Polyester powder coating with phosphochromating pre-finish
Light source	24x2835LED CRI>80
Standard Deviation Color Matching	:MacAdam step 3
Screws	Stainless steel
Transformer	Electronic power supply 220/240V 50/60Hz built-in or AC120-277V/DC12-24V
Gasket	Silicone rubber
Glass	Tempered
Power cable	1 mt. neoprene power cable included
Gross weight	(0.6m)4.5 Kg (0.8m)5.5 Kg (1m)6.5 Kg
Package size	(0.6m)66*23*22cm (0.8m)86*23*22cm (1m)106*23*22cm

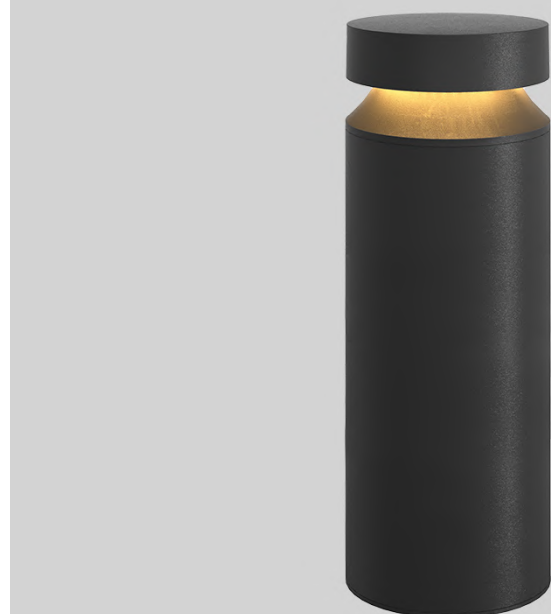

# ECLIPSE

## LT-YS

Super comfort, no glare at all  
 180° and 360° symmetrical light distribution  
 Die-cast aluminum fixture with polyester powder coating on the surface  
 IK08 IP65 protection level  
 Multiple installation options

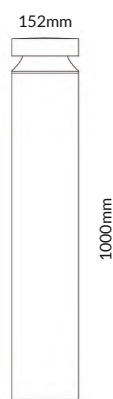

### Option

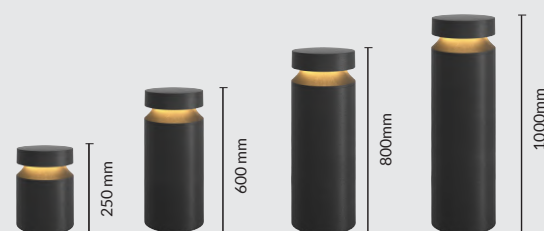

light source*	lumen output (lm)	lumin. efficacy (lm/w)	light beam options
5000K white			
LT-YS-24W	1008.0	42.0	Symmetry (360°)

3000/4000K CCT available on request

### Finish color options :



Customizable in different finishing colors

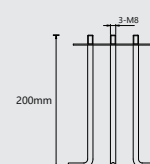

Concrete anchor 1023  
Material: steel  
\*Need to be purchased separately





LI-TIAN LIGHTING

Technical features



360°

Technical data

Wattage	10W
IP Rating	IP65
IK Rating	IK08
Material	High corrosion resistance die-cast copper-free aluminum body +Aluminum profile
Coating	Polyester powder coating with phosphochromating pre-finish
Light source	24x2835LED CRI>80
Standard Deviation Color Matching	:MacAdam step 3
Screws	Stainless steel
Transformer	Electronic power supply 220/240V 50/60Hz built-in or AC120-277V/DC12-24V
Gasket	Silicone rubber
Glass	Tempered
Power cable	1 mt. neoprene power cable included

# ECLIPSE

## LT-YS

Super comfort, no glare at all  
 180° and 360° symmetrical light distribution  
 Die-cast aluminum fixture with polyester powder coating on the surface  
 IK08 IP65 protection level  
 Multiple installation options

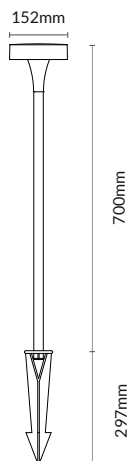

### Option

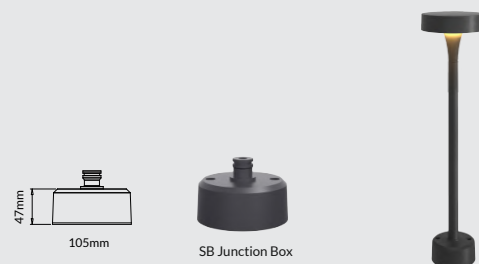

light source*	lumen output (lm)	lumin. efficacy (lm/w)	light beam options
5000K white			
LT-YS-10W	700.0	70.0	Symmetry 360°

3000/4000K CCT available on request

### Finish color options :

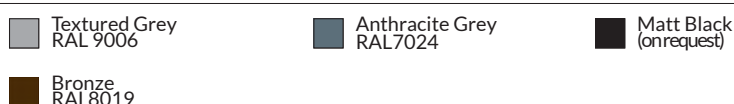

Customizable in different finishing colors







LI-TIAN LIGHTING

Technical features



Technical data

Wattage	7W
IP Rating	IP66
IK Rating	IK06
Material	High corrosion resistance die-cast copper-free aluminum body
Coating	Polyester powder coating with phosphochromating pre-finish
Light source	1xCOB CRI>80
Standard Deviation Color Matching	:MacAdam step 3
Screws	Stainless steel
Transformer	Electronic power supply AC120-277V or DC12-24V
Gasket	Silicone rubber
Glass	Tempered
Power cable	1 mt. neoprene power cable included



# ROSE

## LT-SL BOLLARD LIGHT 1.0

Small bollards for private gardens with various sizes and angles to choose from.

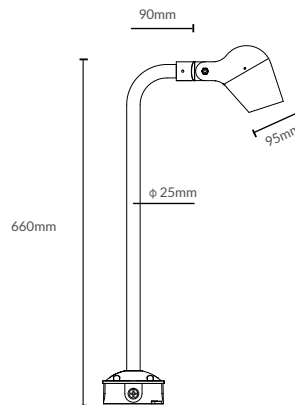

light source*	lumen output (lm)	lumin. efficacy (lm/w)	light beam options										
3000°K warm-white													
7W COB	700.0	100.0	<table border="1"> <tr><td></td><td>15°</td></tr> <tr><td></td><td>24°</td></tr> <tr><td></td><td>36°</td></tr> <tr><td></td><td>60°</td></tr> <tr><td></td><td>40°-70°</td></tr> </table>		15°		24°		36°		60°		40°-70°
	15°												
	24°												
	36°												
	60°												
	40°-70°												

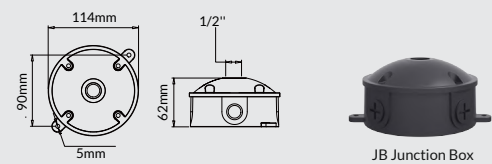

Extension arm

Material: Aluminum profile  
Specification: Thickness 4mm,  $\phi$  25mm  
\*Length can be customized



2700/4000/5000K CCT available on request

Finish color options :

- Textured Grey  
RAL 9006
- Anthracite Grey  
RAL7024
- Matt Black  
(onrequest)
- Bronze  
RAL8019

Customizable in different finishing colors





LI-TIAN LIGHTING

Technical features



Technical data

Wattage	20W
IP Rating	IP66
IK Rating	IK06
Material	High corrosion resistance die-cast copper-free aluminum body
Coating	Polyester powder coating with phosphochromating pre-finish
Light source	1xCOB CRI>90
Standard Deviation Color Matching	:MacAdam step 3
Screws	Stainless steel
Transformer	Electronic power supply AC120-277V or DC12-24V
Gasket	Silicone rubber
Glass	Tempered
Power cable	1 mt. neoprene power cable included
Gross weight	4.5 Kg



# ROSE

## LT-SLBOLLARD LIGHT 2.0

1000mm height bollard, taper shape, for outdoor surface installation, multiple angle glow options, phosphochromatised and polyester powder coated die-cast copper-free aluminium body, polycarbonate diffuser, moulded silicone gasket and stainless steel screws. Anchorage bolts included. Built-in LED driver IP66 rating.

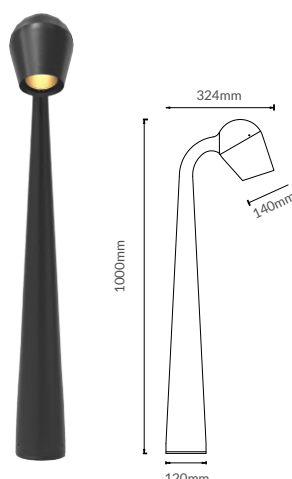

Option

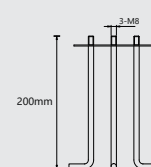

**Concrete anchor 1023**  
Material: steel  
\*Need to be purchased separately

light source*	lumen output (lm)	lumin. efficacy (lm/w)	light beam options
3000°K warm-white			
20W COB	2000.0	100.0	

2700/4000/5000K CCT available on request

Finish color options :



Customizable in different finishing colors





LI-TIAN LIGHTING

Technical features



Technical data

Wattage	10W
IP Rating	IP65
IK Rating	IK06
Material	High corrosion resistance die-cast copper-free aluminum body +Aluminum profile
Coating	Polyester powder coating with phosphochromating pre-finish
Light source	24x2835LED CRI>80
Standard Deviation Color Matching	:MacAdam step 3
Screws	Stainless steel
Transformer	Electronic power supply 220/240V 50/60Hz built-in or AC120-277V/DC12-24V
Gasket	Silicone rubber
Glass	Tempered
Power cable	1 mt. neoprene power cable included
Gross weight	2 Kg



# SHADOW

## LT-YZ

The luminaire is designed on the principle of a reflective three-screen system, which directs the light downwards. The screens have a matte, white, lacquered inside, which diffuses the light so that it becomes comfortable to look at.

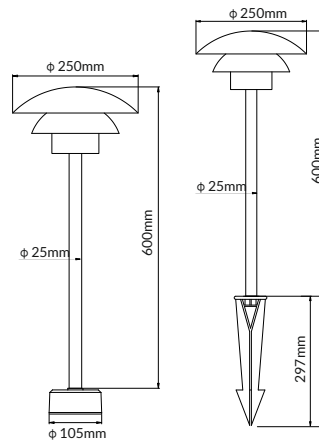

### Option

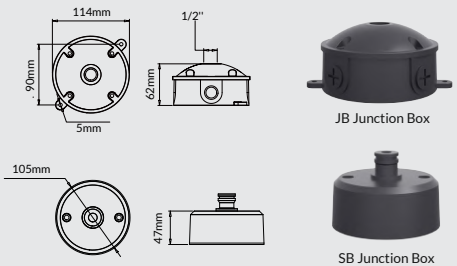
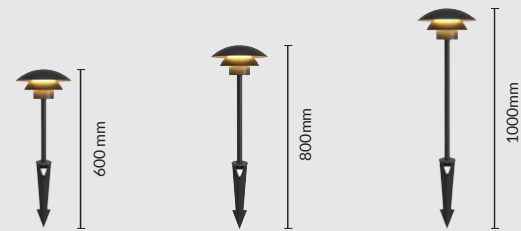

light source*	lumen output (lm)	lumin. efficacy (lm/w)	light beam options
5000K white			
LT-YS-10W	464.0	46.4	Indirect luminescence

3000/4000K CCT available on request

### Finish color options :



Customizable in different finishing colors

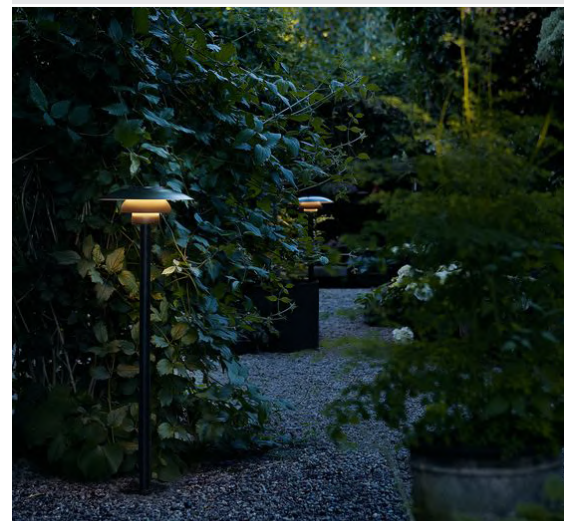



LI-TIAN LIGHTING

Technical features



Technical data

Wattage	10W
IP Rating	IP65
IK Rating	IK06
Material	High corrosion resistance die-cast copper-free aluminum body +Aluminum profile
Coating	Polyester powder coating with phosphochromating pre-finish
Light source	24x2835LED CRI> 80
Standard Deviation Color Matching	:MacAdam step 3
Screws	Stainless steel
Transformer	Electronic power supply 220/240V 50/60Hz built-in or AC120-277V/DC12-24V
Gasket	Silicone rubber
Glass	Tempered
Power cable	1 mt. neoprene power cable included
Gross weight	2 Kg



# SHADOW

## LT-YZ

The luminaire is designed on the principle of a reflective three-screen system, which directs the light downwards. The screens have a matte, white, lacquered inside, which diffuses the light so that it becomes comfortable to look at.

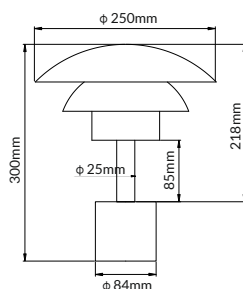

light source*	lumen output (lm)	lumin. efficacy (lm/w)	light beam options
5000K white			
LT-YS-10W	464.0	46.4	Indirect luminescence

3000/4000K CCT available on request

Finish color options :

- Textured Grey RAL 9006
- Anthracite Grey RAL7024
- Matt Black (onrequest)
- Bronze RAL8019

Customizable in different finishing colors

Option



φ 60mm



φ 76mm

Material: Steel, surface hot-dip galvanized treatment and polyester powder spraying

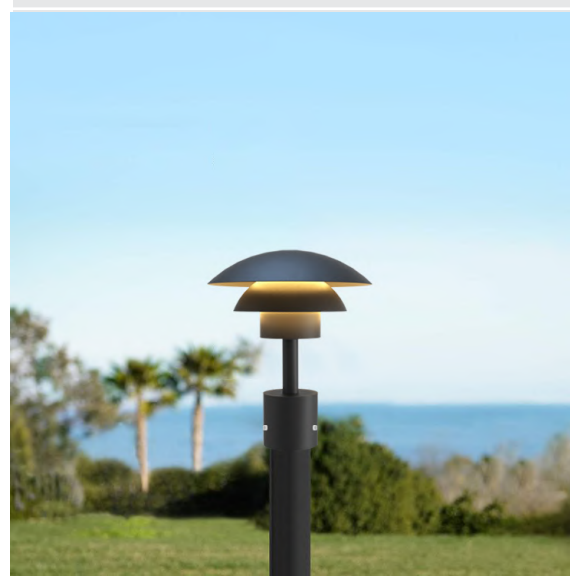



LI-TIAN LIGHTING

# STEP LIGHT





LI-TIAN LIGHTING

Technical features



Technical data

Wattage	6W
IP Rating	IP65
IK Rating	IK06
Material	High corrosion resistance die-cast copper-free aluminum body
Coating	Polyester powder coating with phosphochromating pre-finish
Light source	12x2835LED CRI>80
Standard Deviation Color Matching	:MacAdam step 3
Screws	Stainless steel
Transformer	Electronic power supply 220/240V 50/60Hz built-in
Gasket	Silicone rubber
Glass	Tempered
Power Cables	Internal wiring
Gross weight	1 Kg

# STEP LIGHT

## LT-TJ-Y527

Lighting system for walkways designed for use with LED light sources to ensure high visual comfort.  
Wall installation.  
Built-in LED driver

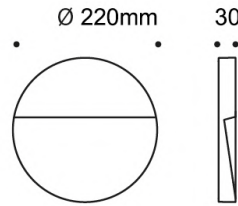

Polar Coordinate Light Distribution Curve

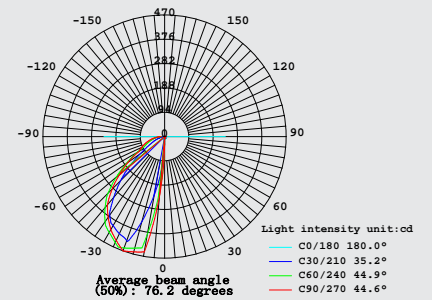

Cartesian coordinate light distribution curve

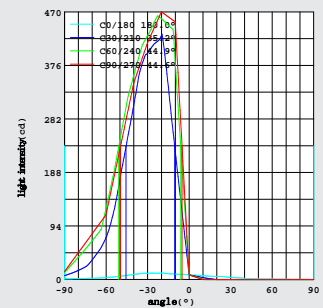

light source*	lumen output (lm)	lumin. efficacy (lm/w)	light beam options
5000K white			
LT-TJ-F527-6W	464.0	76.0	Asymmetric

3000/4000K CCT available on request

Finish color options :



Customizable in different finishing colors





LI-TIAN LIGHTING

Technical features



Technical data

Wattage	6W
IP Rating	IP65
IK Rating	IK06
Material	High corrosion resistance die-cast copper-free aluminum body
Coating	Polyester powder coating with phosphochromating pre-finish
Light source	12x2835LED CRI>80
Standard Deviation Color Matching	:MacAdam step 3
Screws	Stainless steel
Transformer	Electronic power supply 220/240V 50/60Hz built-in
Gasket	Silicone rubber
Glass	Tempered
Power Cables	Internal wiring
Gross weight	1 Kg



# STEP LIGHT

## LT-TJ-F527

Lighting system for walkways designed for use with LED light sources to ensure high visual comfort.  
Wall installation.  
Built-in LED driver

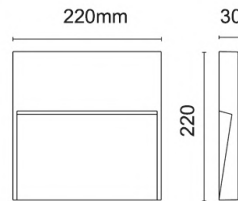

### Polar Coordinate Light Distribution Curve

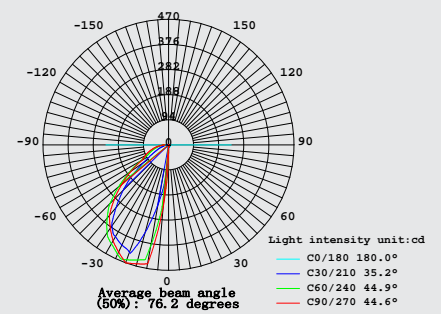

### Cartesian coordinate light distribution curve

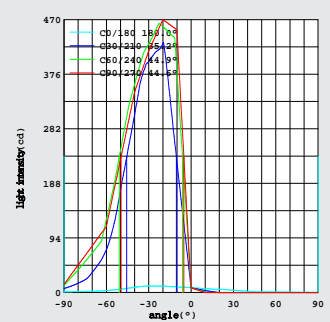

light source*	lumen output (lm)	lumin. efficacy (lm/w)	light beam options
5000K white			
LT-TJ-F527-6W	464.0	76.0	Asymmetric

3000/4000K CCT available on request

### Finish color options :

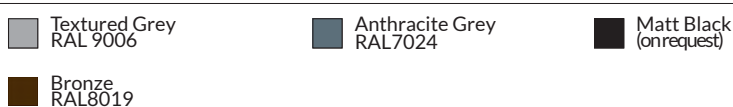

Customizable in different finishing colors



# PORTABLE TABLE LIGHTS

 LI-TIAN LIGHTING







LI-TIAN LIGHTING

Technical features

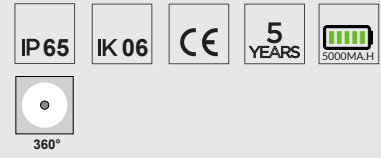

Technical data

Wattage	2.5W
IP Rating	IP65
IK Rating	IK06
Material	High corrosion resistance die-cast copper-free aluminum body
Coating	Polyester powder coating with phosphochromating pre-finish
Light source	12x2835 LED CRI>90
Standard Deviation Color Matching	:MacAdam step 3
Screws	Stainless steel
Battery	5000MA.H
Standby time	8h
Glass	Tempered
Dimming	10-100%
Weight	2kg



# ECLIPSE

## LT-YS

Die-cast aluminum material  
5000ma/h lithium battery  
IP65 protection level  
10-100% dimming range

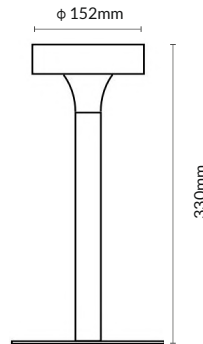

TYPE-C usb line

light source*	lumen output (lm)	lumin. efficacy (lm/w)	light beam options
5000K white			
LT-YS-2.5W	100.0	40.0	Symmetry 360°

3000/4000K CCT available on request

### Option



Black



Rust



Red

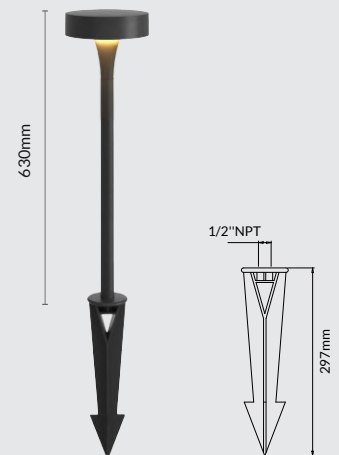

GS Ground Stake  
Material: PC



# URBAN LIGHTS





LI-TIAN LIGHTING

Technical features



Technical data

Wattage	30/50W
IP Rating	IP65
IK Rating	IK08
Material	High corrosion resistance die-cast copper-free aluminum body
Coating	Polyester powder coating with phosphochromating pre-finish
Light source	SMD high-intensity power LEDs
Standard Deviation Color Matching	:MacAdam step 3
Screws	Stainless steel
Transformer	Electronic power supply 220/240V 50/60Hz built-in or AC120-277V
Gasket	Silicone rubber
Glass	Tempered
Power cable	1 mt. neoprene power cable included
Gross weight	7.3 Kg
Surge Protection	6 KV
Notes	Can on request DALI version available on request
Installation type	Smallpox



# SUNFLOWER

## LT-1885-30/50W

SunFlowers blurs the lines between outdoor and indoor luminaires. A curb to cube family approach puts the focus on a variety of mounting options to cover a range of exterior and interior lighting needs. From roadways to pathways, public parks to university campuses, parking lots to lobbies, Sunflower has you covered. Mix and match lighting requirements with a consistent design aesthetic – outdoors and in.

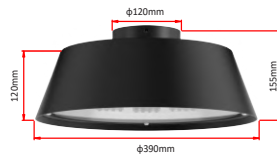

light source*	lumen output (lm)	lumin. efficacy (lm/w)	light beam options
5000°K white			
LT-1885-30W	3390.0	113.0	105°
LT-1885-50W	5650.0		

3000/4000K CCT available on request

Finish color options :

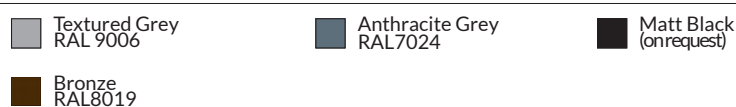

Customizable in different finishing colors





LI-TIAN LIGHTING

Technical features



Technical data

Wattage	30/50W
IP Rating	IP65
IK Rating	IK08
Material	High corrosion resistance die-cast copper-free aluminum body
Coating	Polyester powder coating with phosphochromating pre-finish
Light source	SMD high-intensity power LEDs
Standard Deviation Color Matching	:MacAdam step 3
Screws	Stainless steel
Transformer	Electronic power supply 220/240V 50/60Hz built-in or AC120-277V
Gasket	Silicone rubber
Glass	Tempered
Power cable	1 mt. neoprene power cable included
Gross weight	7.3 Kg
Surge Protection	6 KV
Notes	Can on request DALI version available on request
Installation type	Pendant



# SUNFLOWER

## LT-1885-30/50W

SunFlowers blurs the lines between outdoor and indoor luminaires. A curb to cube family approach puts the focus on a variety of mounting options to cover a range of exterior and interior lighting needs. From roadways to pathways, public parks to university campuses, parking lots to lobbies, Sunflower has you covered. Mix and match lighting requirements with a consistent design aesthetic – outdoors and in.

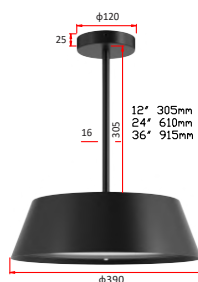

light source*	lumen output (lm)	lumin. efficacy (lm/w)	light beam options
5000°K white			
LT-1885-30W	3390.0	113.0	105°
LT-1885-50W	5650.0		

3000/4000K CCT available on request

Finish color options :

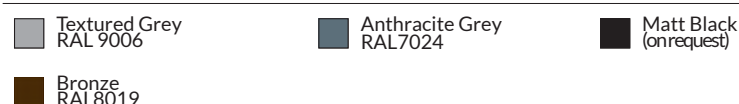

Customizable in different finishing colors



Technical features



Technical data

Wattage	30/50/70/90W
IP Rating	IP65
IK Rating	IK08
Material	High corrosion resistance die-cast copper-free aluminum body
Coating	Polyester powder coating with phosphochromating pre-finish
Light source	SMD high-intensity power LEDs
Standard Deviation Color Matching	MacAdam step 3
Screws	Stainless steel
Transformer	Electronic power supply 220/240V 50/60Hz built-in or AC120-277V
Gasket	Silicone rubber
Glass	Tempered
Power cable	1 mt. neoprene power cable included
Gross weight	8 Kg
Surge Protection	6 KV
Notes	Can on request DALI version available on request
Installation type	Wall



# SUNFLOWER

## LT-1885-30/50/70/90W

SunFlowers blurs the lines between outdoor and indoor luminaires. A curb to cube family approach puts the focus on a variety of mounting options to cover a range of exterior and interior lighting needs. From roadways to pathways, public parks to university campuses, parking lots to lobbies, Sunflower has you covered. Mix and match lighting requirements with a consistent design aesthetic – outdoors and in.

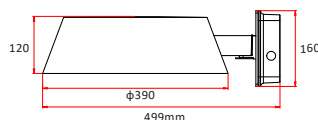

light source*	lumen output (lm)	lumin. efficacy (lm/w)	light beam options
5000°K white			
LT-1885-30W	4950.0	165.0	Type II
LT-1885-50W	8250.0		Type III
LT-1885-70W	11550.0		Type IV
LT-1885-90W	14850.0		Type V

3000/4000K CCT available on request

Finish color options :



Customizable in different finishing colors

Option

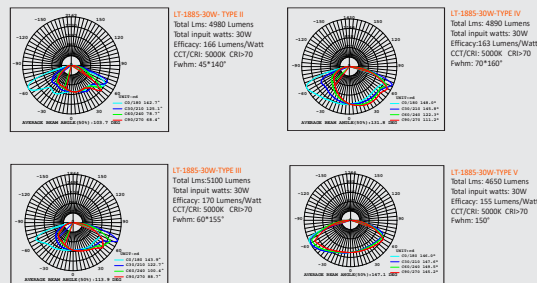



LI-TIAN LIGHTING

Technical features



Technical data

Wattage	30/50/70/90W
IP Rating	IP65
IK Rating	IK08
Material	High corrosion resistance die-cast copper-free aluminum body
Coating	Polyester powder coating with phosphochromating pre-finish
Light source	SMD high-intensity power LEDs
Standard Deviation Color Matching	MacAdam step 3
Screws	Stainless steel
Transformer	Electronic power supply 220/240V 50/60Hz built-in or AC120-277V
Gasket	Silicone rubber
Glass	Tempered
Power cable	1 mt. neoprene power cable included
Gross weight	7.5 Kg
Surge Protection	6 KV
Notes	Can on request DALI version available on request
Installation type	Wall



# SUNFLOWER

## LT-1885-30/50/70/90W

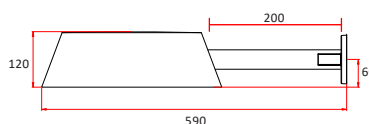

SunFlowers blurs the lines between outdoor and indoor luminaires. A curb to cube family approach puts the focus on a variety of mounting options to cover a range of exterior and interior lighting needs. From roadways to pathways, public parks to university campuses, parking lots to lobbies, Sunflower has you covered. Mix and match lighting requirements with a consistent design aesthetic – outdoors and in.



light source*	lumen output (lm)	lumin. efficacy (lm/w)	light beam options
5000°K white			
LT-1885-30W	4950.0	165.0	Type II
LT-1885-50W	8250.0		Type III
LT-1885-70W	11550.0		Type IV
LT-1885-90W	14850.0		Type V

3000/4000K CCT available on request

Finish color options :

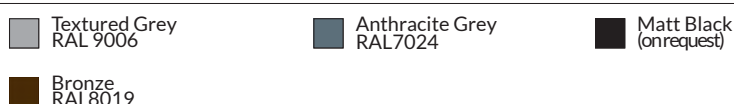

Customizable in different finishing colors

### Option

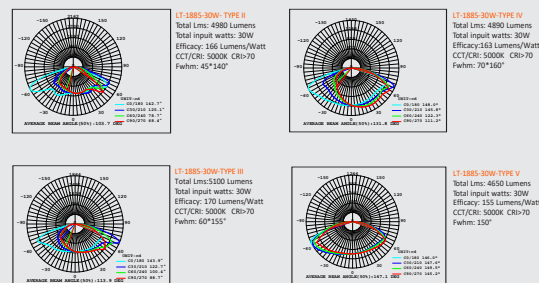



LI-TIAN LIGHTING

Technical features



Technical data

Wattage	30/50/70/90W
IP Rating	IP65
IK Rating	IK08
Material	High corrosion resistance die-cast copper-free aluminum body
Coating	Polyester powder coating with phosphochromating pre-finish
Light source	SMD high-intensity power LEDs
Standard Deviation Color Matching	MacAdam step 3
Screws	Stainless steel
Transformer	Electronic power supply 220/240V 50/60Hz built-in or AC120-277V
Gasket	Silicone rubber
Glass	Tempered
Power cable	1 mt. neoprene power cable included
Gross weight	7.5 Kg
Surge Protection	6 KV
Notes	Can on request DALI version available on request
Installation type	Overhead



# SUNFLOWER

## LT-1885-30/50/70/90W

SunFlowers blurs the lines between outdoor and indoor luminaires. A curb to cube family approach puts the focus on a variety of mounting options to cover a range of exterior and interior lighting needs. From roadways to pathways, public parks to university campuses, parking lots to lobbies, Sunflower has you covered. Mix and match lighting requirements with a consistent design aesthetic – outdoors and in.



### Option

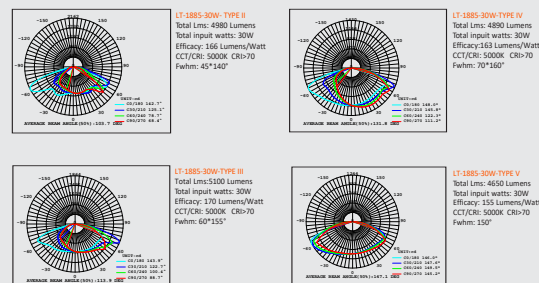

light source*	lumen output (lm)	lumin. efficacy (lm/w)	light beam options
5000°K white			
LT-1885-30W	4950.0	165.0	Type II
LT-1885-50W	8250.0		Type III
LT-1885-70W	11550.0		Type IV
LT-1885-90W	14850.0		Type V

3000/4000K CCT available on request

### Finish color options :

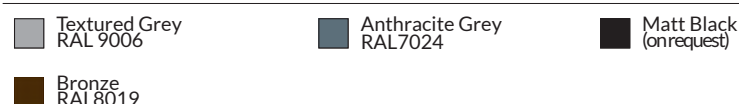

Customizable in different finishing colors





LI-TIAN LIGHTING

Technical features



Technical data

Wattage	30/50/70/90W
IP Rating	IP65
IK Rating	IK08
Material	High corrosion resistance die-cast copper-free aluminum body
Coating	Polyester powder coating with phosphochromating pre-finish
Light source	SMD high-intensity power LEDs
Standard Deviation Color Matching	MacAdam step 3
Screws	Stainless steel
Transformer	Electronic power supply 220/240V 50/60Hz built-in or AC120-277V
Gasket	Silicone rubber
Glass	Tempered
Power cable	1 mt. neoprene power cable included
Gross weight	8.1Kg
Surge Protection	6 KV
Notes	Can on request DALI version available on request
Installation type	Slip Fitter



# SUNFLOWER

## LT-1885-30/50/70/90W

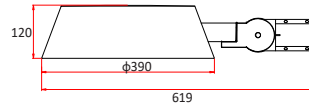

SunFlowers blurs the lines between outdoor and indoor luminaires. A curb to cube family approach puts the focus on a variety of mounting options to cover a range of exterior and interior lighting needs. From roadways to pathways, public parks to university campuses, parking lots to lobbies, Sunflower has you covered. Mix and match lighting requirements with a consistent design aesthetic – outdoors and in.



light source*	lumen output (lm)	lumin. efficacy (lm/w)	light beam options
5000°K white			
LT-1885-30W	4950.0	165.0	Type II
LT-1885-50W	8250.0		Type III
LT-1885-70W	11550.0		Type IV
LT-1885-90W	14850.0		Type V

3000/4000K CCT available on request

Finish color options :



Customizable in different finishing colors

### Option

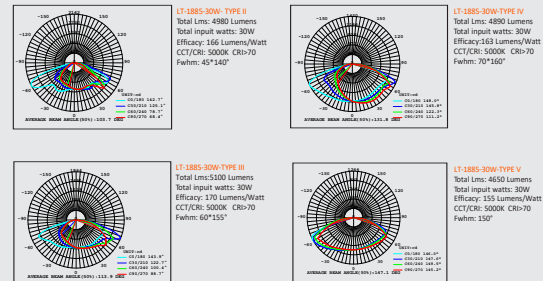





LI-TIAN LIGHTING

Technical features



Technical data

Wattage	30/50/70/90W
IP Rating	IP65
IK Rating	IK08
Material	High corrosion resistance die-cast copper-free aluminum body
Coating	Polyester powder coating with phosphochromating pre-finish
Light source	SMD high-intensity power LEDs
Standard Deviation Color Matching	MacAdam step 3
Screws	Stainless steel
Transformer	Electronic power supply 220/240V 50/60Hz built-in or AC120-277V
Gasket	Silicone rubber
Glass	Tempered
Power cable	1 mt. neoprene power cable included
Gross weight	7.3 Kg
Surge Protection	6 KV
Notes	Can on request DALI version available on request
Installation type	Pole Mount



# SUNFLOWER

## LT-1885-30/50/70/90W

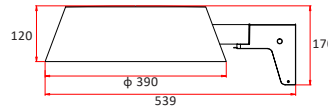

SunFlowers blurs the lines between outdoor and indoor luminaires. A curb to cube family approach puts the focus on a variety of mounting options to cover a range of exterior and interior lighting needs. From roadways to pathways, public parks to university campuses, parking lots to lobbies, Sunflower has you covered. Mix and match lighting requirements with a consistent design aesthetic – outdoors and in.



### Option

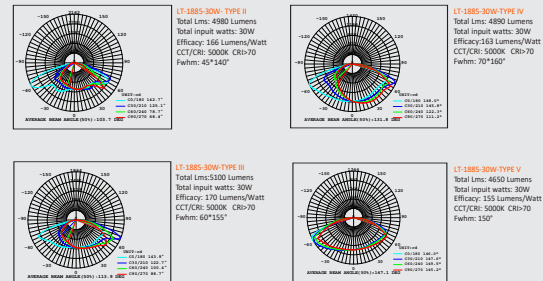

light source*	lumen output (lm)	lumin. efficacy (lm/w)	light beam options
5000°K white			
LT-1885-30W	4950.0	165.0	Type II
LT-1885-50W	8250.0		Type III
LT-1885-70W	11550.0		Type IV
LT-1885-90W	14850.0		Type V

3000/4000K CCT available on request

### Finish color options :



Customizable in different finishing colors





LI-TIAN LIGHTING

Technical features



Technical data

Wattage	30/50/70/90W
IP Rating	IP65
IK Rating	IK08
Material	High corrosion resistance die-cast copper-free aluminum body
Coating	Polyester powder coating with phosphochromating pre-finish
Light source	SMD high-intensity power LEDs
Standard Deviation Color Matching	MacAdam step 3
Screws	Stainless steel
Transformer	Electronic power supply 220/240V 50/60Hz built-in or AC120-277V
Gasket	Silicone rubber
Glass	Tempered
Power cable	1 mt. neoprene power cable included
Gross weight	7.5 Kg
Surge Protection	6 KV
Notes	Can on request DALI version available on request
Installation type	Pole Mount



# SUNFLOWER

## LT-1885-30/50/70/90W

SunFlowers blurs the lines between outdoor and indoor luminaires. A curb to cube family approach puts the focus on a variety of mounting options to cover a range of exterior and interior lighting needs. From roadways to pathways, public parks to university campuses, parking lots to lobbies, Sunflower has you covered. Mix and match lighting requirements with a consistent design aesthetic – outdoors and in.

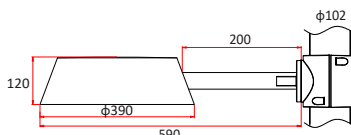

light source*	lumen output (lm)	lumin. efficacy (lm/w)	light beam options
5000°K white			
LT-1885-30W	4950.0	165.0	Type II
LT-1885-50W	8250.0		Type III
LT-1885-70W	11550.0		Type IV
LT-1885-90W	14850.0		Type V

3000/4000K CCT available on request

Finish color options :

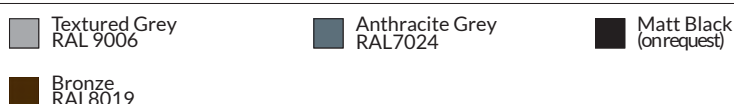

Customizable in different finishing colors

### Option

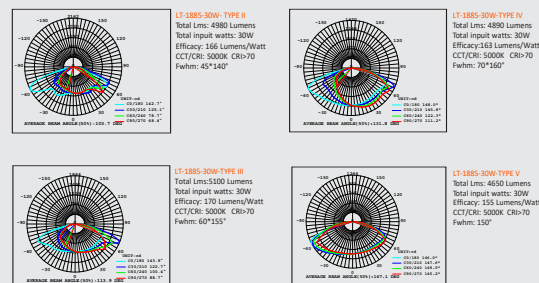



LI-TIAN LIGHTING

Technical features



Technical data

Wattage	30/50/70/90W
IP Rating	IP65
IK Rating	IK08
Material	High corrosion resistance die-cast copper-free aluminum body
Coating	Polyester powder coating with phosphochromating pre-finish
Light source	SMD high-intensity power LEDs
Standard Deviation Color Matching	MacAdam step 3
Screws	Stainless steel
Transformer	Electronic power supply 220/240V 50/60Hz built-in or AC120-277V
Gasket	Silicone rubber
Glass	Tempered
Power cable	1 mt. neoprene power cable included
Gross weight	7.3 Kg
Surge Protection	6 KV
Notes	Can on request DALI version available on request
Installation type	Pole Mount

# SUNFLOWER

## LT-1885-30/50/70/90W

SunFlowers blurs the lines between outdoor and indoor luminaires. A curb to cube family approach puts the focus on a variety of mounting options to cover a range of exterior and interior lighting needs. From roadways to pathways, public parks to university campuses, parking lots to lobbies, Sunflower has you covered. Mix and match lighting requirements with a consistent design aesthetic – outdoors and in.

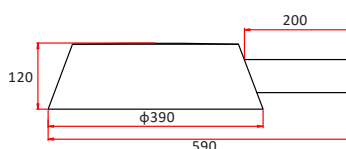

light source*	lumen output (lm)	lumin. efficacy (lm/w)	light beam options
5000°K white			
LT-1885-30W	4950.0	165.0	Type II
LT-1885-50W	8250.0		Type III
LT-1885-70W	11550.0		Type IV
LT-1885-90W	14850.0		Type V

3000/4000K CCT available on request

Finish color options :

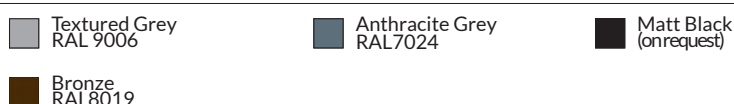

Customizable in different finishing colors

### Option

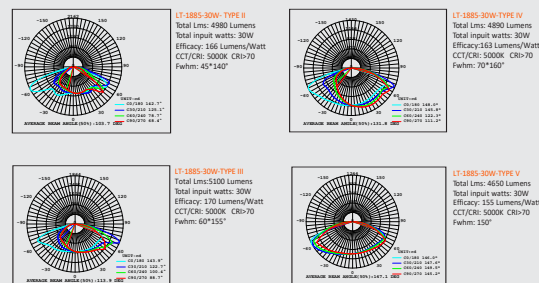



LI-TIAN LIGHTING

Technical features



Technical data

Wattage	30/50/70/90W
IP Rating	IP65
IK Rating	IK08
Material	High corrosion resistance die-cast copper-free aluminum body
Coating	Polyester powder coating with phosphochromating pre-finish
Light source	SMD high-intensity power LEDs
Standard Deviation Color Matching	MacAdam step 3
Screws	Stainless steel
Transformer	Electronic power supply 220/240V 50/60Hz built-in or AC120-277V
Gasket	Silicone rubber
Glass	Tempered
Power cable	1 mt. neoprene power cable included
Gross weight	7.3 Kg
Surge Protection	6 KV
Notes	Can on request DALI version available on request
Installation type	Catenary Mount



# SUNFLOWER

## LT-1885-30/50/70/90W

SunFlowers blurs the lines between outdoor and indoor luminaires. A curb to cube family approach puts the focus on a variety of mounting options to cover a range of exterior and interior lighting needs. From roadways to pathways, public parks to university campuses, parking lots to lobbies, Sunflower has you covered. Mix and match lighting requirements with a consistent design aesthetic – outdoors and in.

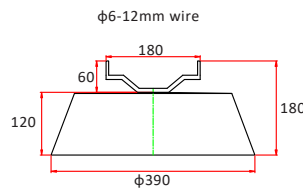

### Option

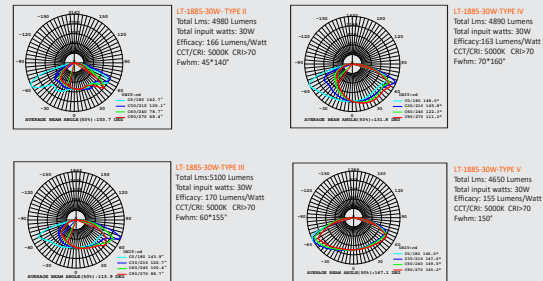

light source*	lumen output (lm)	lumin. efficacy (lm/w)	light beam options
5000°K white			
LT-1885-30W	4950.0	165.0	Type II
LT-1885-50W	8250.0		Type III
LT-1885-70W	11550.0		Type IV
LT-1885-90W	14850.0		Type V

3000/4000K CCT available on request

### Finish color options :

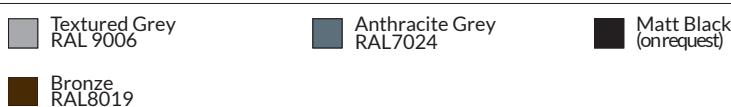

Customizable in different finishing colors





LI-TIAN LIGHTING

Technical features



Technical data

Wattage	50/70/100W
IP Rating	IP66
IK Rating	IK08
Material	High corrosion resistance die-cast copper-free aluminum body
Coating	Polyester powder coating with phosphochromating pre-finish
Light source	SMD high-intensity power LEDs
Standard Deviation Color Matching	:MacAdam step 3
Screws	Stainless steel
Transformer	Electronic power supply 220/240V 50/60Hz built-in or AC120-277V
Gasket	Silicone rubber
Glass	Tempered
Power cable	1 mt. neoprene power cable included
Gross weight	7.3 Kg
Surge Protection	6 KV
Notes	Can on request DALI version available on request



# PARASOL

## LT-DZ-50/70/100W

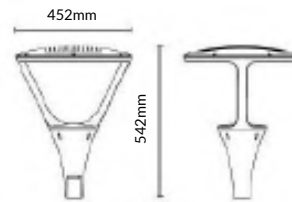

Die-cast aluminium body (EN 47100).  
 Double layer polyester powder paint resistant to corrosion and salt spray fog.  
 Silicone rubber gaskets.  
 AISI 316 stainless steel external screws.  
 Driver protected against voltage surges.  
 PMMA lenses for LEDs.  
 Screen made of 5mm thermal-shock resistant tempered glass.

Option

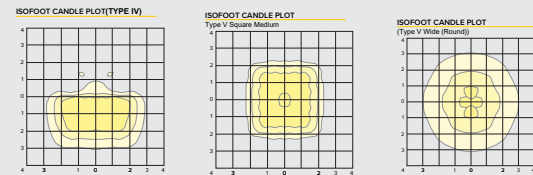
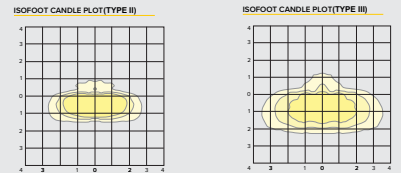

light source*	lumen output (lm)	lumin. efficacy (lm/w)	light beam options
5000°K white			
LT-OS-50W	6000.0	120.0	Type II
			Type III
LT-OS-70W	8400.0		Type IV
			Type IV Wide
LT-OS-100W	1200.0		Type V Square Medium
			Type V Wide (Round)

3000/4000K CCT available on request

Finish color options :

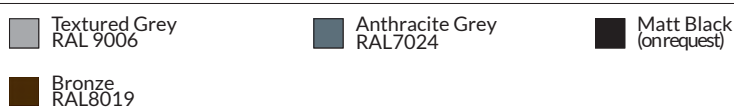

Customizable in different finishing colors





LI-TIAN LIGHTING

Technical features



Technical data

Wattage	24W
IP Rating	IP65
IK Rating	IK08
Material	High corrosion resistance die-cast copper-free aluminum body +Aluminum profile
Coating	Polyester powder coating with phosphochromating pre-finish
Light source	8x5050LED CRI>80
Standard Deviation Color Matching	:MacAdam step 3
Screws	Stainless steel
Transformer	Electronic power supply 220/240V 50/60Hz built-in or AC120-277V/DC12-24V
Gasket	Silicone rubber
Glass	Tempered
Power Cables	Neoprene cable 3x0.75
Power cable	1 mt. neoprene power cable included

Lamp body material: Polycarbonate powder spraying on the surface of aluminum profile



# LAUGH

## LT-BL-UT-24W

A series of LED light building elements with asymmetrical light distribution. Light building elements are luminous design features for public areas. They are ideally suited for delineating and structuring interior and exterior spaces such as landscape areas, plazas, building entrances

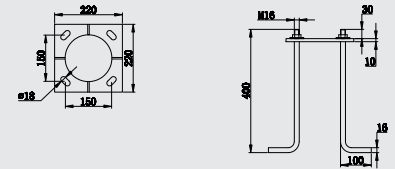

Concrete anchor 1024  
Material: steel  
\*Need to be purchased separately

light source*	lumen output (lm)	lumin. efficacy (lm/w)	light beam options
5000K white			
LT-BL-UT-24W	1920.0	80.0	Asymmetric (70x150°)

3000/4000K CCT available on request Unilateral light output

Finish color options :

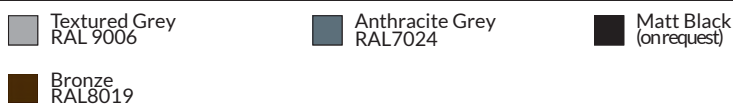

Customizable in different finishing colors





LI-TIAN LIGHTING

Technical features



Technical data

Wattage	48W
IP Rating	IP65
IK Rating	IK08
Material	High corrosion resistance die-cast copper-free aluminum body +Aluminum profile
Coating	Polyester powder coating with phosphochromating pre-finish
Light source	16x5050LED CRI>80
Standard Deviation Color Matching	:MacAdam step 3
Screws	Stainless steel
Transformer	Electronic power supply 220/240V 50/60Hz built-in or AC120-277V/DC12-24V
Gasket	Silicone rubber
Glass	Tempered
Power Cables	Neoprene cable 3x0.75
Power cable	1 mt. neoprene power cable included

Lamp body material: Polycarbonate powder spraying on the surface of aluminum profile

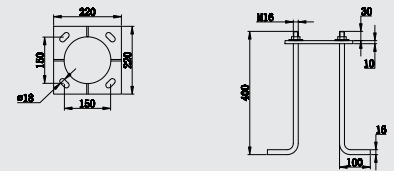

Concrete anchor 1024  
Material: steel  
\*Need to be purchased separately

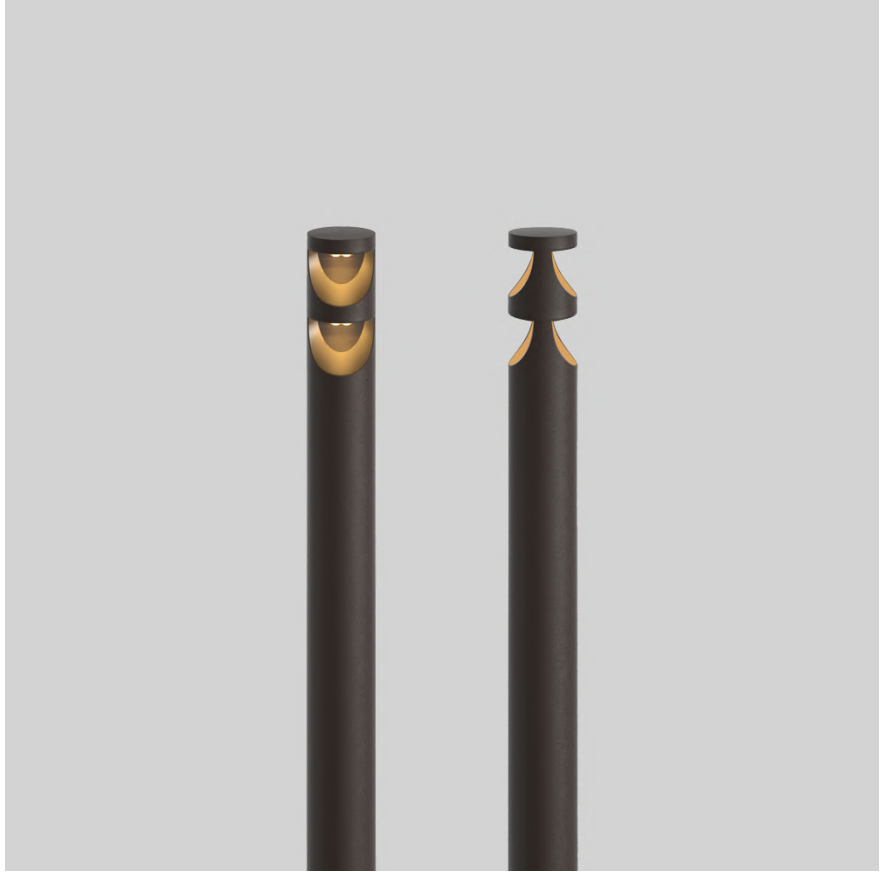

# LAUGH

## LT-BL-UT-48W

A series of LED light building elements with asymmetrical light distribution.

Light building elements are luminous design features for public areas.

They are ideally suited for delineating and structuring interior and exterior spaces such as landscape areas, plazas, building entrances

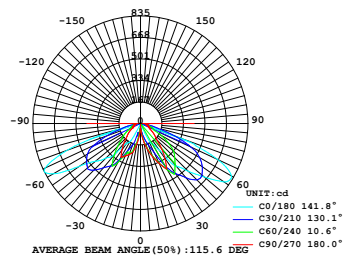

light source*	lumen output (lm)	lumin. efficacy (lm/w)	light beam options
5000K white			
LT-BL-UT-48W	3840.0	80.0	Asymmetric 2*(70x150°)

3000/4000K CCT available on request

Unilateral light output

Finish color options :

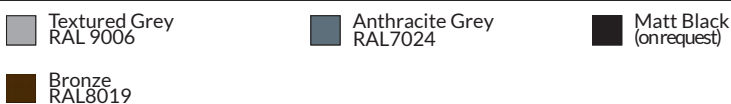

Customizable in different finishing colors





LI-TIAN LIGHTING

Technical features



Technical data

Wattage	36W
IP Rating	IP65
IK Rating	IK08
Material	High corrosion resistance die-cast copper-free aluminum body +Aluminum profile
Coating	Polyester powder coating with phosphochromating pre-finish
Light source	12x5050LED CRI>80
Standard Deviation Color Matching	:MacAdam step 3
Screws	Stainless steel
Transformer	Electronic power supply 220/240V 50/60Hz built-in or AC120-277V/DC12-24V
Gasket	Silicone rubber
Glass	Tempered
Power cable	1 mt. neoprene power cable included

Lamp body material: Polycarbonate powder spraying on the surface of aluminum profile



# LAUGH

## LT-BL-UT-36W

A series of LED light building elements with asymmetrical light distribution.

Light building elements are luminous design features for public areas.

They are ideally suited for delineating and structuring interior and exterior spaces such as landscape areas, plazas, building entrances

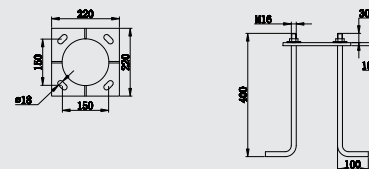
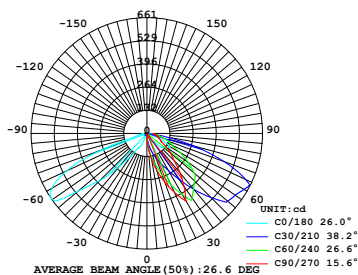

Concrete anchor 1024  
Material: steel  
\*Need to be purchased separately

light source*	lumen output (lm)	lumin. efficacy (lm/w)	light beam options
5000K white			
LT-BL-UT-36W	2880.0	80.0	Asymmetric (70x150°)

3000/4000K CCT available on request Unilateral light output

Finish color options :

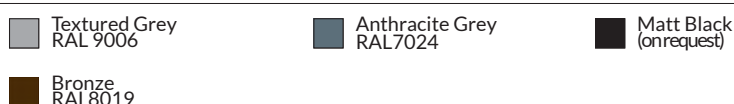

Customizable in different finishing colors







LI-TIAN LIGHTING

Technical features



Technical data

Wattage	72W
IP Rating	IP65
IK Rating	IK08
Material	High corrosion resistance die-cast copper-free aluminum body +Aluminum profile
Coating	Polyester powder coating with phosphochromating pre-finish
Light source	24x5050LED CRI>80
Standard Deviation Color Matching	:MacAdam step 3
Screws	Stainless steel
Transformer	Electronic power supply 220/240V 50/60Hz built-in or AC120-277V/DC12-24V
Gasket	Silicone rubber
Glass	Tempered
Power cable	1 mt. neoprene power cable included

Lamp body material: Polycarbonate powder spraying on the surface of aluminum profile

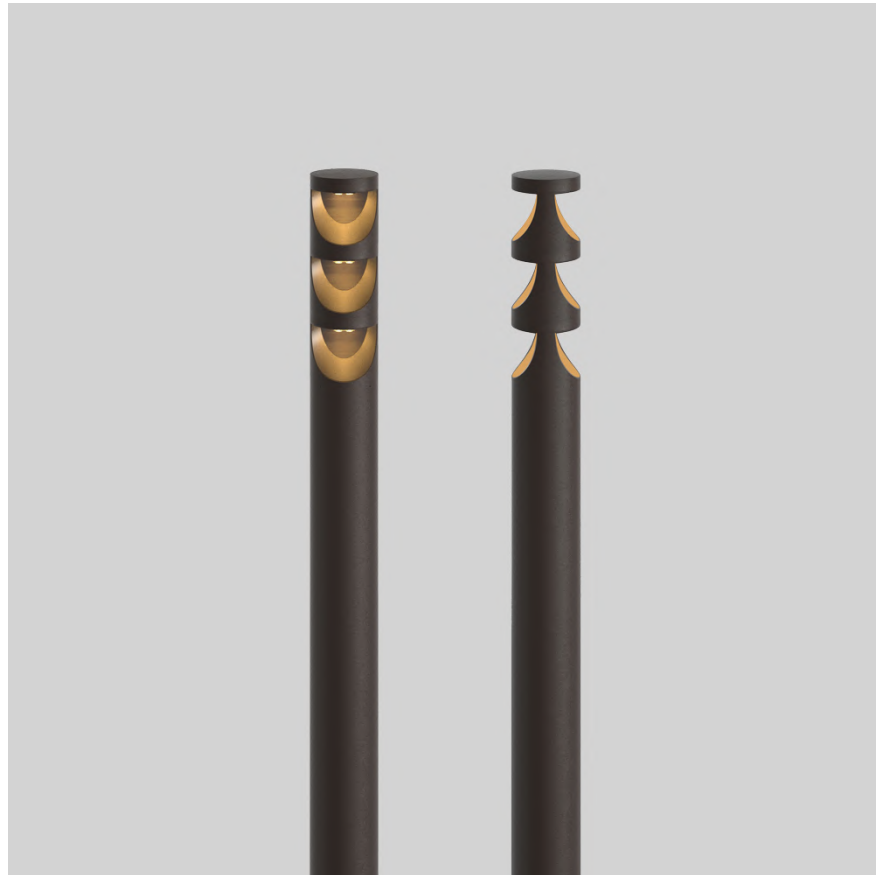

# LAUGH

## LT-BL-UT-72W

A series of LED light building elements with asymmetrical light distribution.

Light building elements are luminous design features for public areas.

They are ideally suited for delineating and structuring interior and exterior spaces such as landscape areas, plazas, building entrances

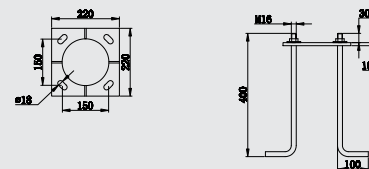
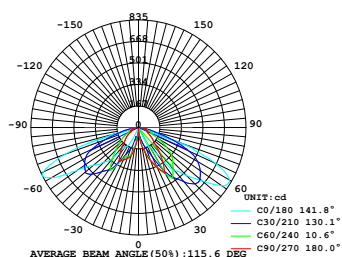

Concrete anchor 1024  
Material: steel  
\*Need to be purchased separately

light source*	lumen output (lm)	lumin. efficacy (lm/w)	light beam options
5000K white			
LT-BL-UT-72W	5760.0	80.0	Asymmetric 2*(70x150°)

3000/4000K CCT available on request Unilateral light output

Finish color options :



Customizable in different finishing colors



# WALL MOUNTING

 LI-TIAN LIGHTING





LI-TIAN LIGHTING

Technical features



Technical data

Wattage	5/20/30W
IP Rating	IP65
IK Rating	IK06
Material	High corrosion resistance die-cast copper-free aluminum body +Acrylic
Coating	Polyester powder coating with phosphochromating pre-finish
Light source	High-Brightness LED CRI>80
Standard Deviation Color Matching	:MacAdam step 3
Screws	Stainless steel
Transformer	Electronic power supply 120-277V 50/60Hz built-in
Gasket	Silicone rubber
Glass	Tempered
Power Cables	Internal wiring
Gross weight	1 Kg



# POPLAR

## LT-BY

The Poplar outdoor wall sconce creates an elegant elongated column of beautifully diffused light. The Poplar is available in three sizes (20cm,40cm,60cm) to meet architectural scale; ideal for way-finding and general outdoor illumination. The Poplar features energy-efficient, fully dimmable integrated LED lamping(Dimming options). Available in two finishes: Bronze and Oak grain.

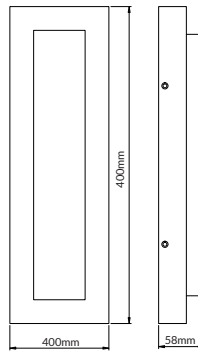

### Option

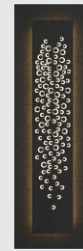

Grape



Willow

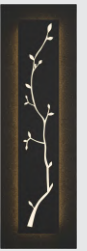

Plum

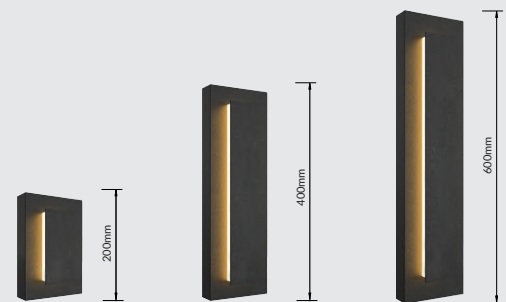

light source*	lumen output (lm)	lumin. efficacy (lm/w)	light beam options
<b>5000K white</b>			
LT-BY-5W	150.0	30.0	Asymmetric
LT-BY-20W	600.0		
LT-BY-30W	900.0		

3000/4000K CCT available on request

### Finish color options :



Customizable in different finishing colors





LI-TIAN LIGHTING

Technical features



Technical data

Wattage	20W
IP Rating	IP65
IK Rating	IK06
Material	High corrosion resistance die-cast copper-free aluminum body +Aluminum profile
Coating	Polyester powder coating with phosphochromating pre-finish
Light source	High-Brightness LED CRI>80
Standard Deviation Color Matching	:MacAdam step 3
Screws	Stainless steel
Transformer	Electronic power supply 120-277V 50/60Hz built-in
Gasket	Silicone rubber
Glass	Tempered
Power Cables	Internal wiring
Gross weight	1 Kg

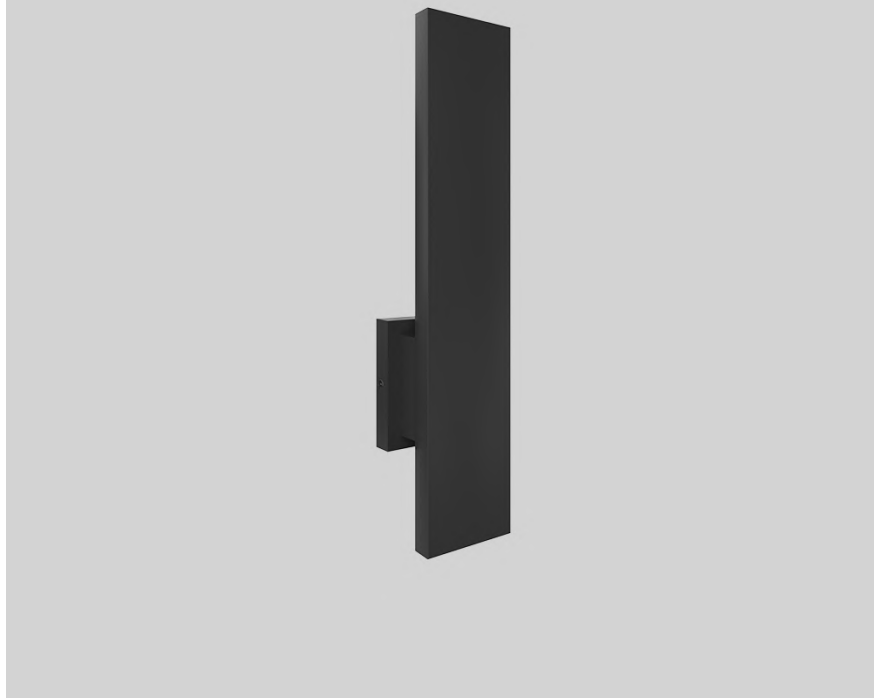

# BLADE

## LT-WW-18

The contemporary aesthetic of the LT-WW-18 outdoor wall sconce creates soft indirect, reduced-glare illumination by aiming light back against the wall for accenting architecture as well as for wayfinding.

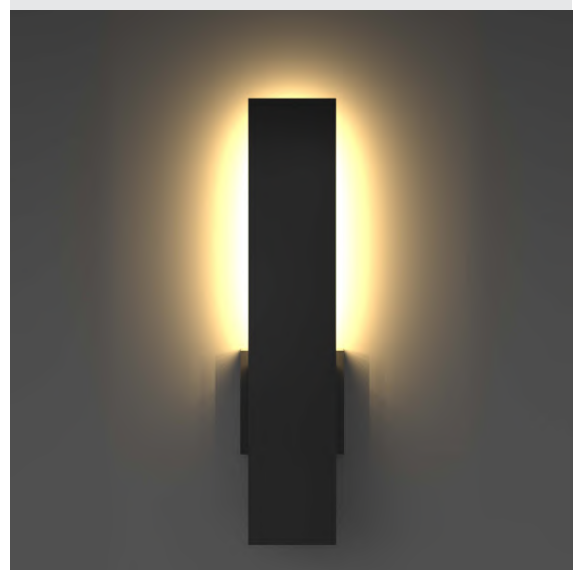
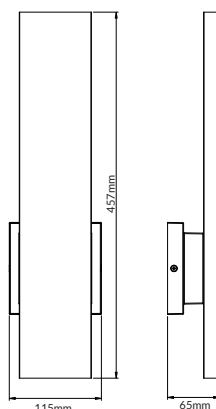

light source*	lumen output (lm)	lumin. efficacy (lm/w)	light beam options
5000K white			
LT-WW-18-20W	1200.0	60.0	Asymmetric

3000/4000K CCT available on request

Finish color options :

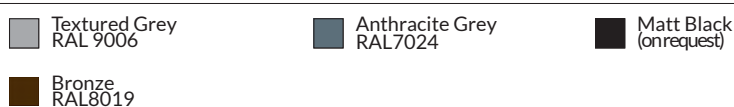

Customizable in different finishing colors

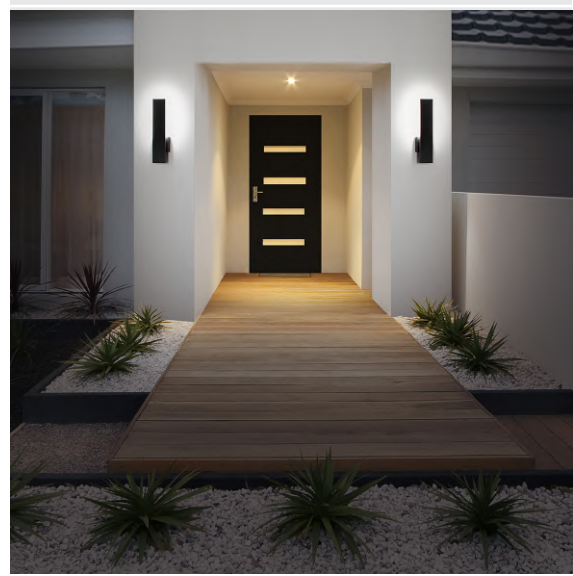



LI-TIAN LIGHTING

Technical features



Technical data

Wattage	12W
IP Rating	IP65
IK Rating	IK06
Material	High corrosion resistance die-cast copper-free aluminum body +Aluminum profile
Coating	Polyester powder coating with phosphochromating pre-finish
Light source	High-Brightness LED CRI>80
Standard Deviation Color Matching	MacAdam step 3
Screws	Stainless steel
Transformer	Electronic power supply 220-240V or 120-277V 50/60Hz built-in
Gasket	Silicone rubber
Glass	Tempered
Power Cables	Internal wiring
Gross weight	1 Kg

# BLADE

## LT-CL

Strikingly elegant in its simplicity, LT-CL is a tubular design that creates a modern industrial look. Designed with a die-cast aluminum structure, powder coat finish, and stainless steel hardware for robust durability in harsh elements. Appropriate for commercial use. Available as Square or Round in three sizes.

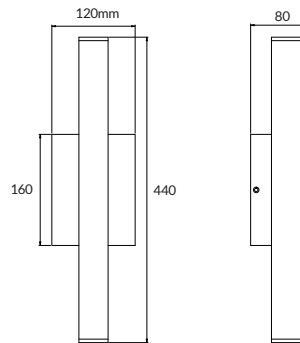

Total Lumen Output: 1286  
 Total Power: 11.8  
 Luminaire Efficacy: 109  
 Color Temp: 3000K  
 CRI: 80+  
 BUG Rating:

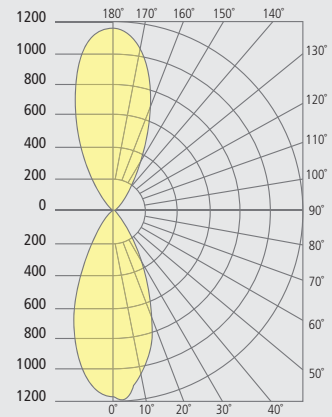

light source*	lumen output (lm)	lumin. efficacy (lm/w)	light beam options
5000K white			
LT-CL-12W	1286.0	100.0	15° 24° 36°

3000/4000K CCT available on request

Finish color options :

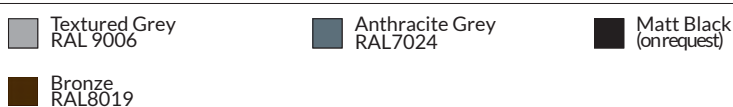

Customizable in different finishing colors

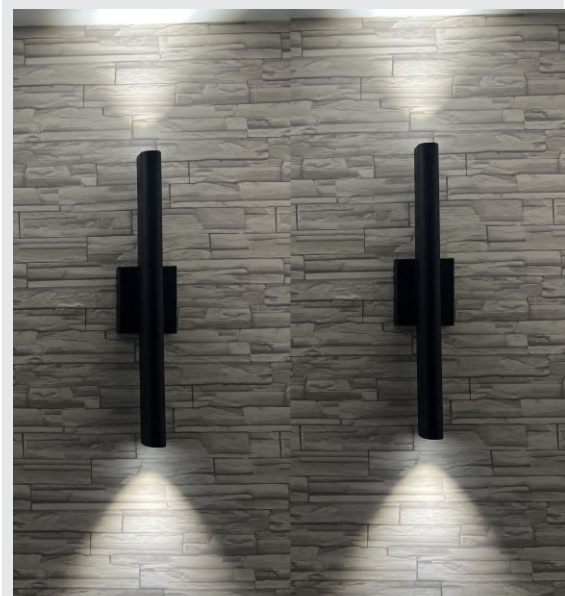



LI-TIAN LIGHTING

Technical features



Technical data

Wattage	12W
IP Rating	IP65
IK Rating	IK06
Material	High corrosion resistance die-cast copper-free aluminum body +Aluminum profile
Coating	Polyester powder coating with phosphochromating pre-finish
Light source	High-Brightness LED CRI>80
Standard Deviation Color Matching	:MacAdam step 3
Screws	Stainless steel
Transformer	Electronic power supply 220-240V or 120-277V 50/60Hz built-in
Gasket	Silicone rubber
Glass	Tempered
Power Cables	Internal wiring
Gross weight	1 Kg

# BLADE

## LT-CL

Strikingly elegant in its simplicity, LT-CL is a tubular design that creates a modern industrial look. Designed with a die-cast aluminum structure, powder coat finish, and stainless steel hardware for robust durability in harsh elements. Appropriate for commercial use. Available as Square or Round in three sizes.

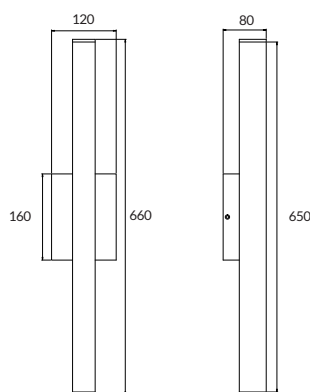

Total Lumen Output:	1286
Total Power:	11.8
Luminaire Efficacy:	109
Color Temp:	3000K
CRI:	80+
BUG Rating:	B1-U4-G0

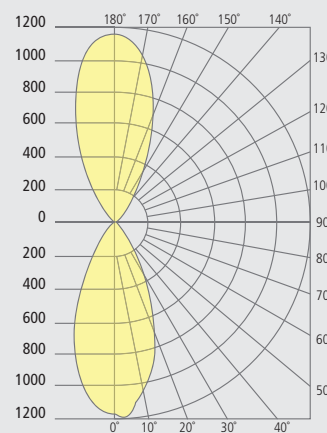

light source*	lumen output (lm)	lumin. efficacy (lm/w)	light beam options
5000K white			
LT-CL-12W	1286.0	100.0	15° 24° 36°

3000/4000K CCT available on request

Finish color options :

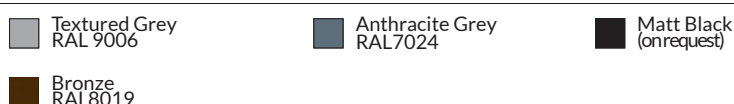

Customizable in different finishing colors





LI-TIAN LIGHTING

Technical features



Technical data

Wattage	12W
IP Rating	IP65
IK Rating	IK06
Material	High corrosion resistance die-cast copper-free aluminum body +Aluminum profile
Coating	Polyester powder coating with phosphochromating pre-finish
Light source	High-Brightness LED CRI>80
Standard Deviation Color Matching	:MacAdam step 3
Screws	Stainless steel
Transformer	Electronic power supply 220-240V or 120-277V 50/60Hz built-in
Gasket	Silicone rubber
Glass	Tempered
Power Cables	Internal wiring
Gross weight	1 Kg

# BLADE

## LT-WL

Strikingly elegant in its simplicity, LT-CL is a tubular design that creates a modern industrial look. Designed with a die-cast aluminum structure, powder coat finish, and stainless steel hardware for robust durability in harsh elements. Appropriate for commercial use. Available as Square or Round in three sizes.

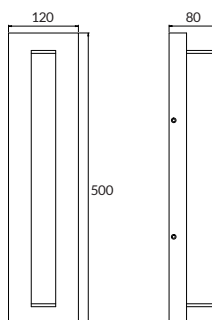

Total Lumen Output:	1286
Total Power:	11.8
Luminaire Efficacy:	109
Color Temp:	3000K
CRI:	80+
BUG Rating:	B1-U4-G0

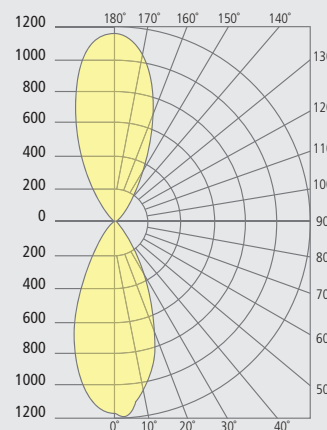

light source*	lumen output (lm)	lumin. efficacy (lm/w)	light beam options
5000K white			
LT-WL-12W	1286.0	100.0	15° 24° 36°

3000/4000K CCT available on request

Finish color options :

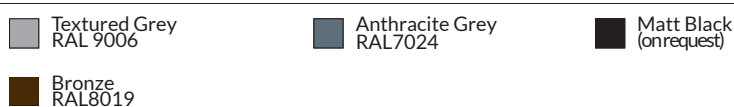

Customizable in different finishing colors





LI-TIAN LIGHTING

Technical features



Technical data

Wattage	15/20/25W
IP Rating	IP65
IK Rating	IK06
Material	High corrosion resistance die-cast copper-free aluminum body
Coating	Polyester powder coating with phosphochromating pre-finish
Light source	1x COB CRI>80
Standard Deviation Color Matching	:MacAdam step 3
Screws	Stainless steel
Transformer	Electronic power supply 120-277V 50/60Hz built-in
Gasket	Silicone rubber
Glass	Reflective cup
Power Cables	Internal wiring
Gross weight	1.2 Kg



# LT-XT-06

Heavy duty die-cast aluminum housing and door. The door frame is fully gasketed to keep out moisture and dust for the luminaire. Specular thermoplastic reflector and clear glass lens. Integral secondary heat sink to optimize thermal transfer and maximize performance and life of LED. Driver is mounted in direct contact with the casting for a low operating temperature and long life.

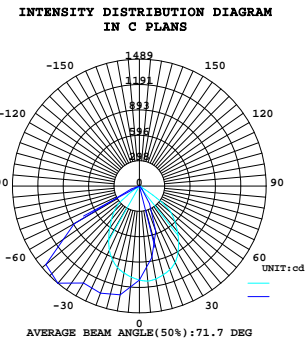
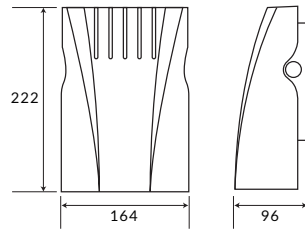

### Option



Extra swivel photocell sensor available

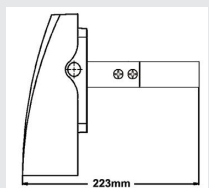

Stainless steel U-shaped bracket

light source*	lumen output (lm)	lumin. efficacy (lm/w)	light beam options
5000K white			
LT-XT-06-15W	1500.0	100.0	Asymmetric
LT-XT-06-20W	2000.0		
LT-XT-06-25W	2500.0		

3000/4000K CCT available on request

### Finish color options :



Customizable in different finishing colors





# RECESSED

FOR OUTDOOR APPLICATIONS





LI-TIAN LIGHTING

Technical features



Technical data

Wattage	5W
IP Rating	IP66
IK Rating	IK08
Material	316 stainless steel
Coating	Stainless steel natural color
Light source	High-Brightness LED CRI>80
Standard Deviation Color Matching	:MacAdam step 3
Screws	Stainless steel
Transformer	DC24V
Glass	5mm tempered glass
Power cable	1 mt. neoprene power cable included
Gross weight	1 Kg



# LT-BM-316

Vandal resistant polycarbonate molded housing cover and lens,maximize performance and life of LED Driver is mounted in direct contact with the chamber for a low operating temperature and long life Polyester powder-coated finish, rust and corrosion proof, stabilized to extreme climate changes without cracking or peeling.

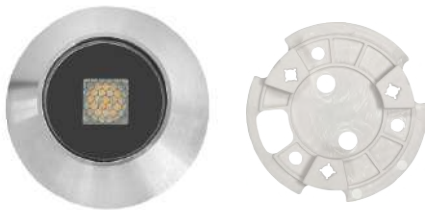
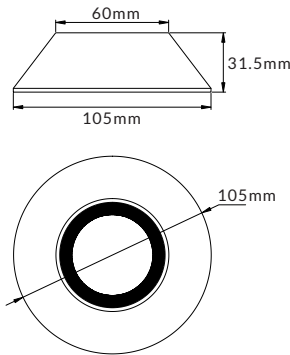

Surface mount base

light source*	lumen output (lm)	lumin. efficacy (lm/w)	light beam options
5000K white			
LT-BM-316-5W	450.0	90.0	8/11/15/30/45 /66/40*12°

3000/4000K CCT available on request

Light distribution options:

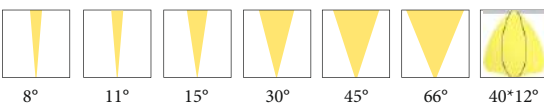

Option

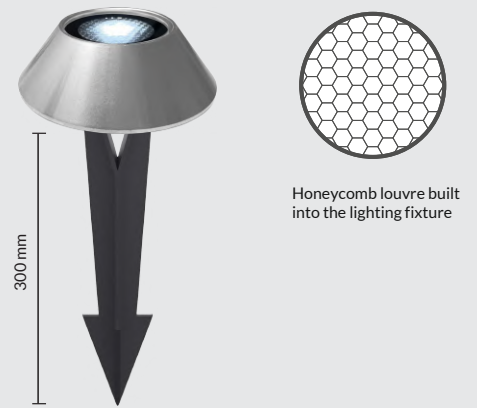

Honeycomb louvre built into the lighting fixture

GS Ground Stake  
Material: PC





LI-TIAN LIGHTING

Technical features



Technical data

Wattage	6W
IP Rating	IP66
IK Rating	IK08
Material	304 stainless steel
Coating	Stainless steel natural color
Light source	High-Brightness LED CRI>80
Standard Deviation Color Matching	:MacAdam step 3
Screws	Stainless steel
Transformer	AC220-240V
Glass	5mm tempered glass
Power cable	1 mt. neoprene power cable included
Dimension	φ120mm
Gross weight	1.1 Kg



# LT-DMD-130-6W

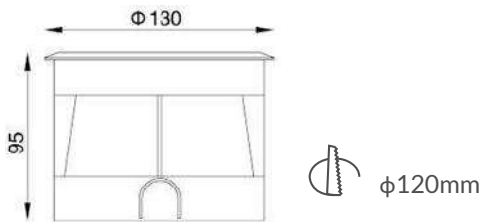
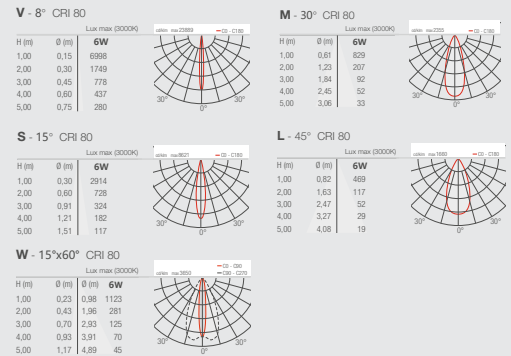

light source*	lumen output (lm)	lumin. efficacy (lm/w)	light beam options
5000K white			
LT-DMD-130-6W	540.0	90.0	8/15/30/45 /15*60°

3000/4000K CCT available on request

Light distribution options:

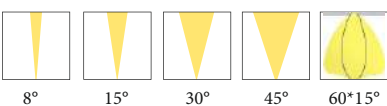



LI-TIAN LIGHTING

Technical features



Technical data

Wattage	9W
IP Rating	IP66
IK Rating	IK08
Material	304 stainless steel
Coating	Stainless steel natural color
Light source	High-Brightness LED CRI>80
Standard Deviation Color Matching	MacAdam step 3
Screws	Stainless steel
Transformer	AC220-240V
Glass	5mm tempered glass
Power cable	1 mt. neoprene power cable included
Dimension	φ145mm
Gross weight	1.8 Kg



# LT-DMD-160-9W

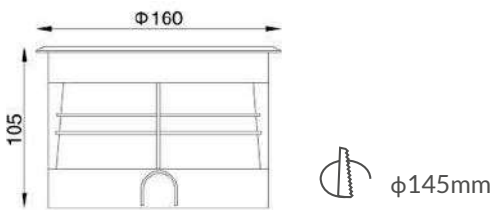
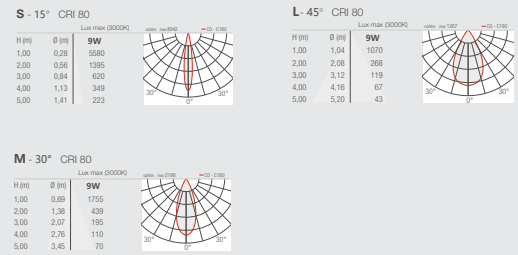

light source*	lumen output (lm)	lumin. efficacy (lm/w)	light beam options
5000K white			
LT-DMD-160-9W	810.0	90.0	8/15/30/45 /15*60°

3000/4000K CCT available on request

Light distribution options:

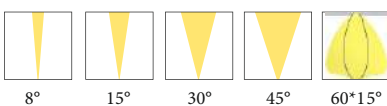



LI-TIAN LIGHTING

Technical features

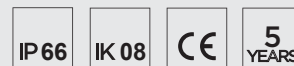

Technical data

Wattage	18W
IP Rating	IP66
IK Rating	IK08
Material	304stainless steel
Coating	Stainless steel natural color
Light source	High-Brightness LED CRI>80
Standard Deviation Color Matching	:MacAdam step 3
Screws	Stainless steel
Transformer	AC220-240V
Glass	5mm tempered glass
Power cable	1 mt. neoprene power cable included
Dimension	φ215mm
Gross weight	3.3 Kg



# LT-DMD-230-18W

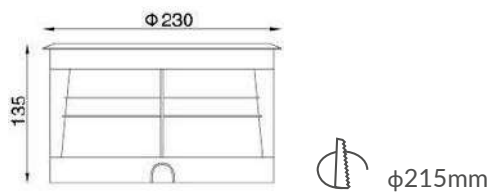
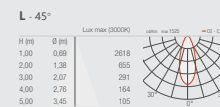
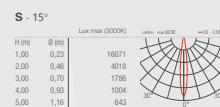

light source*	lumen output (lm)	lumin. efficacy (lm/w)	light beam options
5000K white			
LT-DMD-230-18W	1620.0	90.0	8/15/30/45 /15*60°

3000/4000K CCT available on request

Light distribution options:

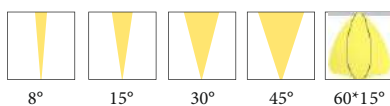



LI-TIAN LIGHTING

Technical features



Technical data

Wattage	24W
IP Rating	IP66
IK Rating	IK08
Material	304 stainless steel
Coating	Stainless steel natural color
Light source	High-Brightness LED CRI>80
Standard Deviation Color Matching	:MacAdam step 3
Screws	Stainless steel
Transformer	AC 220-240V
Glass	5mm tempered glass
Power cable	1 mt. neoprene power cable included
Dimension	φ240mm
Gross weight	4.2 Kg



# LT-DMD-260-24W

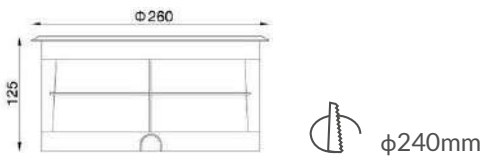
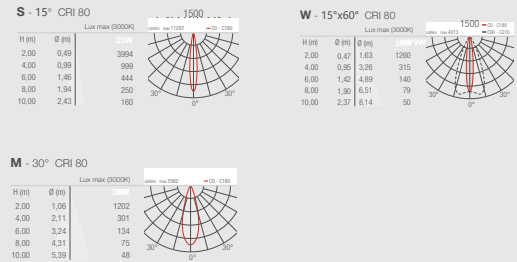

light source*	lumen output (lm)	lumin. efficacy (lm/w)	light beam options
5000K white			
LT-DMD-230-24W	2160.0	90.0	8/15/30/45 /15°*60°

3000/4000K CCT available on request

Light distribution options:

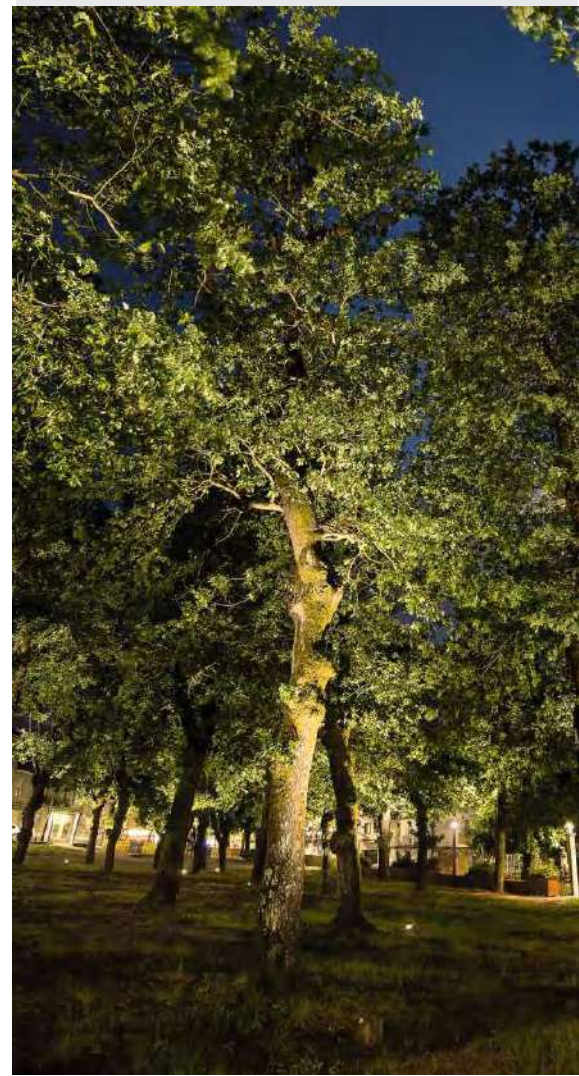
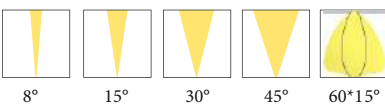



LI-TIAN LIGHTING

Technical features



Technical data

Wattage	7W
IP Rating	IP66
IK Rating	IK08
Material	304 stainless steel
Coating	Stainless steel natural color
Light source	1xCOB CRI>80
Standard Deviation Color Matching	MacAdam step 3
Screws	Stainless steel
Transformer	AC220-240V
Glass	5mm tempered glass
Power cable	1 mt. neoprene power cable included
Dimension	φ90mm
Gross weight	1Kg



# LT-DMD-100-7W

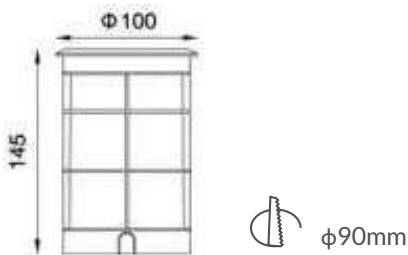
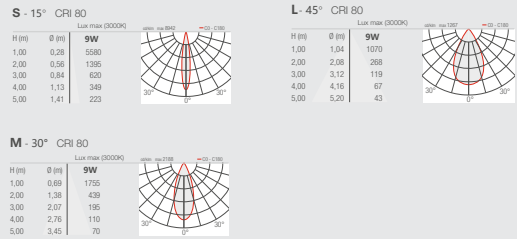

light source*	lumen output (lm)	lumin. efficacy (lm/w)	light beam options
5000K white			
LT-DMD-160-7W	630.0	90.0	15/24/45/60°

3000/4000K CCT available on request

Light distribution options:

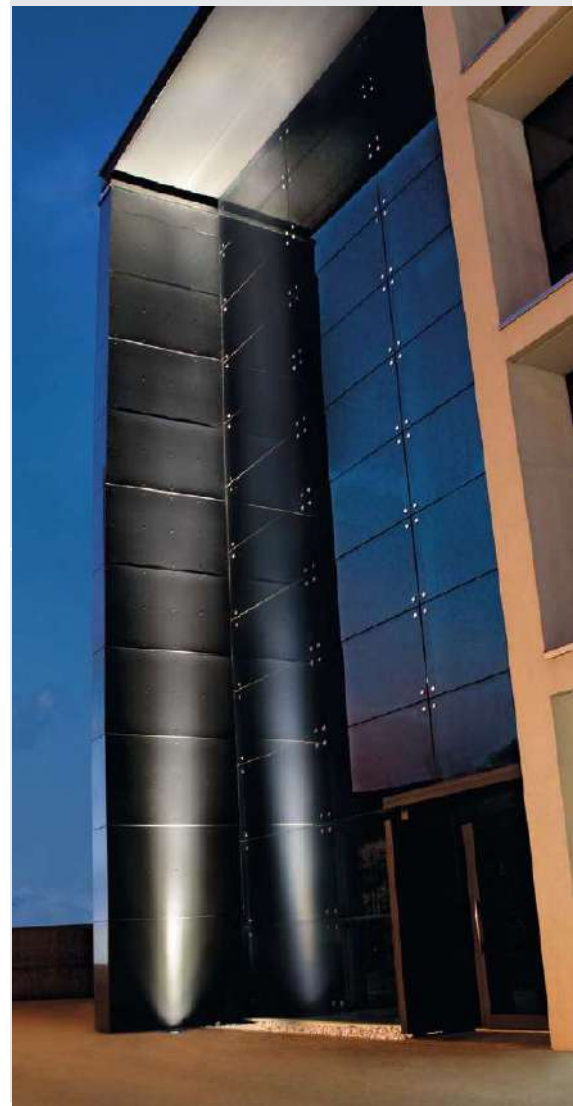
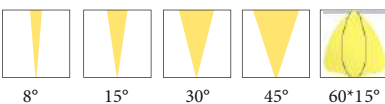



LI-TIAN LIGHTING

Technical features



Technical data

Wattage	7W
IP Rating	IP66
IK Rating	IK08
Material	304 stainless steel
Coating	Stainless steel natural color
Light source	1xCOB CRI>80
Standard Deviation Color Matching	:MacAdam step 3
Screws	Stainless steel
Transformer	AC220-240V
Glass	5mm tempered glass
Power cable	1 mt. neoprene power cable included
Dimension	φ105mm
Gross weight	1 Kg



# LT-DMD-120-7W

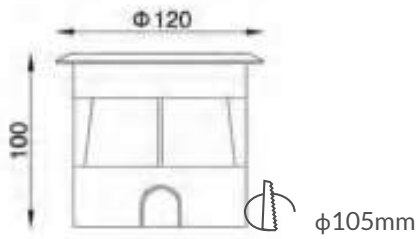

light source*	lumen output (lm)	lumin. efficacy (lm/w)	light beam options
5000K white			
LT-DMD-120-7W	630.0	90.0	15/24/45/60°

3000/4000K CCT available on request

Light distribution options:

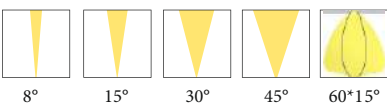





LI-TIAN LIGHTING

Technical features



Technical data

Wattage	15W
IP Rating	IP66
IK Rating	IK08
Material	304 stainless steel
Coating	Stainless steel natural color
Light source	1xCOB CRI>80
Standard Deviation Color Matching	:MacAdam step 3
Screws	Stainless steel
Transformer	AC220-240V
Glass	5mm tempered glass
Power cable	1 mt. neoprene power cable included
Dimension	φ170mm
Gross weight	2Kg



# LT-DMD-180-15W

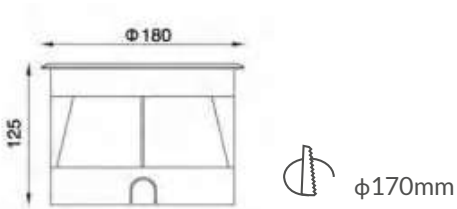

light source*	lumen output (lm)	lumin. efficacy (lm/w)	light beam options
5000K white			
LT-DMD-180-15W	1350.0	90.0	15/24/45/60°

3000/4000K CCT available on request

Light distribution options:

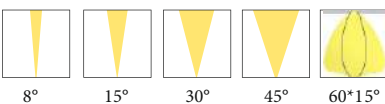



LI-TIAN LIGHTING

Technical features



Technical data

Wattage	10W
IP Rating	IP66
IK Rating	IK08
Material	304 stainless steel
Coating	Stainless steel natural color
Light source	1xCOB CRI>80
Standard Deviation Color Matching	:MacAdam step 3
Screws	Stainless steel
Transformer	AC220-240V
Glass	5mm tempered glass
Power cable	1 mt. neoprene power cable included
Dimension	φ135mm
Gross weight	1.5Kg



# LT-DMD-150-10W

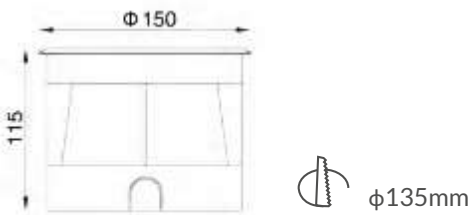

light source*	lumen output (lm)	lumin. efficacy (lm/w)	light beam options
5000K white			
LT-DMD-150-10W	900.0	90.0	15/24/45/60°

3000/4000K CCT available on request

Light distribution options:

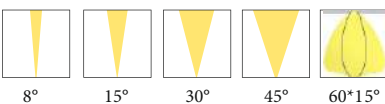



LI-TIAN LIGHTING

Technical features



Technical data

Wattage	30W
IP Rating	IP66
IK Rating	IK08
Material	304 stainless steel
Coating	Stainless steel natural color
Light source	1xCOB CRI>80
Standard Deviation Color Matching	:MacAdam step 3
Screws	Stainless steel
Transformer	AC220-240V
Glass	5mm tempered glass
Power cable	1 mt. neoprene power cable included
Dimension	φ245mm
Gross weight	4.2Kg



# LT-DMD-260-30W

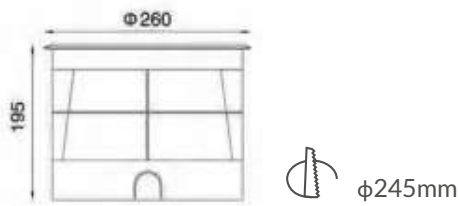

light source*	lumen output (lm)	lumin. efficacy (lm/w)	light beam options
5000K white			
LT-DMD-260-30W	2700.0	90.0	15/24/45/60°

3000/4000K CCT available on request

Light distribution options:

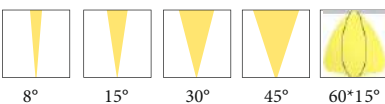

# STREET LAMP

 LI-TIAN LIGHTING





LI-TIAN LIGHTING

Technical features



Technical data

Wattage	100/150/200W
IP Rating	IP65
IK Rating	IK06
Material	High corrosion resistance die-cast copper-free aluminum body
Coating	Polyester powder coating with phosphochromating pre-finish
Light source	144/200/288 x 3030LED CRI>70
Standard Deviation Color Matching :MacAdam step 3	
Screws	Stainless steel
Transformer	Electronic power supply 220/240V 50/60Hz built-in or AC120-277V
Gasket	Silicone rubber
Glass	Tempered
Power Cables	Neoprene cable 3x0.75
Gross weight	5.5 Kg
Surge Protection	6 KV



# LTOK

## LT-OK-100/150/200W

The LTOK LED area/site luminaire delivers exceptional performance in a scalable, low-profile design. The precision engineered optics provide uniform illumination to walkways, parking lots, roadways, building areas and security lighting applications. Backed by a five-year limited warranty, the LTOK LED area/site luminaire is the LED answer to your area and site lighting needs.

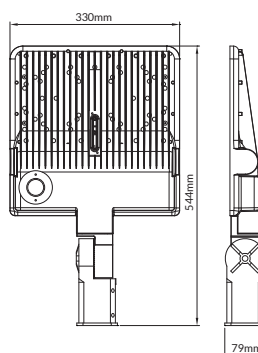

light source*	lumen output (lm)	lumin. efficacy (lm/w)	light beam options
5000°K white			
LT-OK-100W	14000.0	140.0	TYPE II 45°155°
LT-OK-150W	21000.0		TYPE V 135°
LT-OK-200W	28000.0		Asymmetric TYPE III(73x149°)
			Asymmetric TYPE IV(86x153°)

3000/4000K CCT available on request

Finish color options :

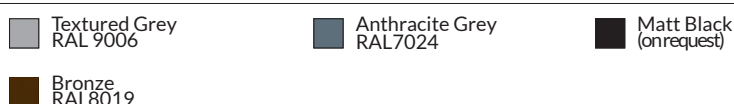

Customizable in different finishing colors

Option

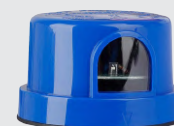
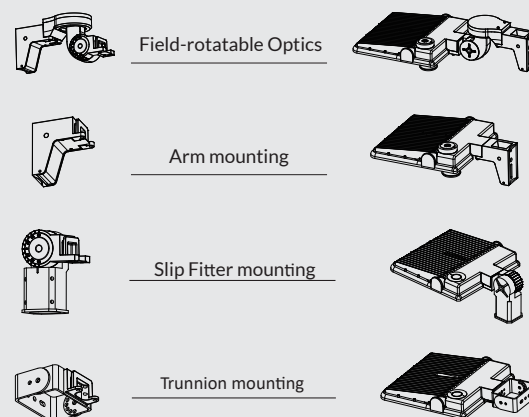

Photocell





LI-TIAN LIGHTING

Technical features



Technical data

Wattage	300W
IP Rating	IP65
IK Rating	IK06
Material	High corrosion resistance die-cast copper-free aluminum body
Coating	Polyester powder coating with phosphochromating pre-finish
Light source	464 x 3030LED CRI>70
Standard Deviation Color Matching :MacAdam step 3	
Screws	Stainless steel
Transformer	Electronic power supply 220/240V 50/60Hz built-in or AC120-277V
Gasket	Silicone rubber
Glass	Tempered
Power cable	1 mt. neoprene power cable included
Gross weight	8.4Kg
Surge Protection	6 KV



# LTOK

## LT-OK-300W

The LTOK LED area/site luminaire delivers exceptional performance in a scalable, low-profile design. The precision engineered optics provide uniform illumination to walkways, parking lots, roadways, building areas and security lighting applications. Backed by a five-year limited warranty, the LTOK LED area/site luminaire is the LED answer to your area and site lighting needs.

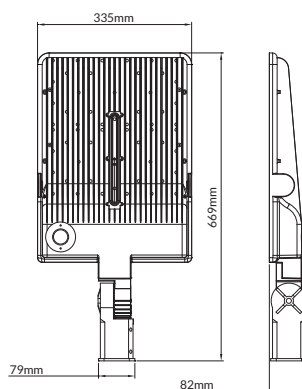

Option

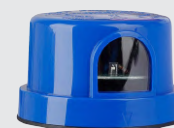
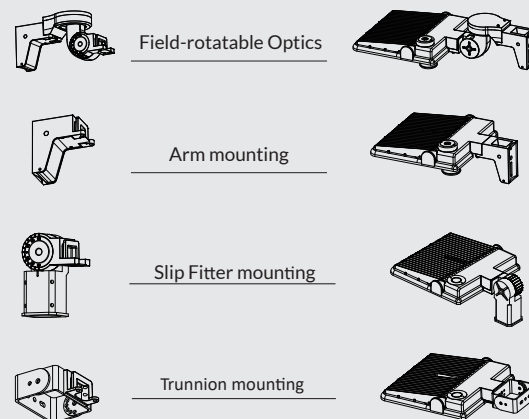

Photocell

light source*	lumen output (lm)	lumin. efficacy (lm/w)	light beam options
5000°K white			TYPE II 45°155°
LT-OK-300W	42000.0	140.0	TYPE V 135°
			Asymmetric TYPE III(73x149°)
			Asymmetric TYPE IV(86x153°)

3000/4000K CCT available on request

Finish color options :

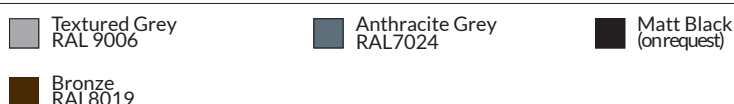

Customizable in different finishing colors





LI-TIAN LIGHTING

Technical features



Technical data

Wattage	50/70W
IP Rating	IP65
IK Rating	IK08
Material	High corrosion resistance die-cast copper-free aluminum body
Coating	Polyester powder coating with phosphochromating pre-finish
Light source	SMD high-intensity power LEDs
Standard Deviation Color Matching	:MacAdam step 3
Screws	Stainless steel
Transformer	Electronic power supply 220/240V 50/60Hz built-in or AC120-277V
Gasket	Silicone rubber
Glass	Tempered
Power cable	1 mt. neoprene power cable included
Gross weight	3.8 Kg
Surge Protection	6 KV/10KV
Notes	Can on request DALI version available on request



# LT-OS-50/70W

Die-cast aluminium body (EN 47100).  
 Double layer polyester powder paint resistant to corrosion and salt spray fog.  
 Silicone rubber gaskets.  
 AISI 316 stainless steel external screws.  
 Driver protected against voltage surges up to 10kV.  
 PMMA lenses for LEDs.  
 Screen made of 5mm thermal-shock resistant tempered glass.  
 High quality LED sources characterized according to IES TM-30, with high color consistency <3SDCM and long useful life >60000 hours at L80.

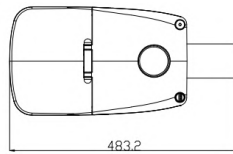
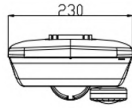

### Option



Photocell



light source*	lumen output (lm)	lumin. efficacy (lm/w)	light beam options
5000°K white			
LT-OS-50W	6500.0	130.0	Type II
			Type III
			Type IV
			Type IV Wide
			Type V Square Medium
LT-OS-70W	9100.0		Type V Wide (Round)

3000/4000K CCT available on request

### Finish color options :

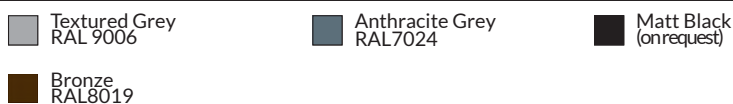

Customizable in different finishing colors

ISOFOOT CANDLE PLOT (TYPE II)

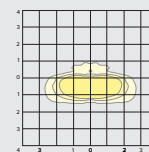

ISOFOOT CANDLE PLOT (TYPE III)

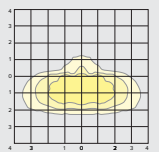

ISOFOOT CANDLE PLOT (TYPE IV)

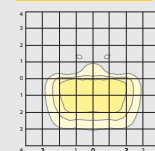

ISOFOOT CANDLE PLOT Type V Square Medium

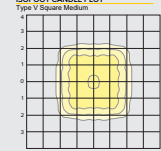

ISOFOOT CANDLE PLOT (Type V Wide (Round))

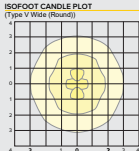



LI-TIAN LIGHTING

Technical features



Technical data

Wattage	100W
IP Rating	IP65
IK Rating	IK08
Material	High corrosion resistance die-cast copper-free aluminum body
Coating	Polyester powder coating with phosphochromating pre-finish
Light source	SMD high-intensity power LEDs
Standard Deviation Color Matching	:MacAdam step 3
Screws	Stainless steel
Transformer	Electronic power supply 220/240V 50/60Hz built-in or AC120-277V
Gasket	Silicone rubber
Glass	Tempered
Power cable	1 mt. neoprene power cable included
Gross weight	4.2 Kg
Surge Protection	6 KV/10KV
Notes	Can on request DALI version available on request



# LT-OS-100W

Die-cast aluminium body (EN 47100).  
 Double layer polyester powder paint resistant to corrosion and salt spray fog.  
 Silicone rubber gaskets.  
 AISI 316 stainless steel external screws.  
 Driver protected against voltage surges up to 10kV.  
 PMMA lenses for LEDs.  
 Screen made of 5mm thermal-shock resistant tempered glass.  
 High quality LED sources characterized according to IES TM-30, with high color consistency <3SDCM and long useful life >60000 hours at L80.

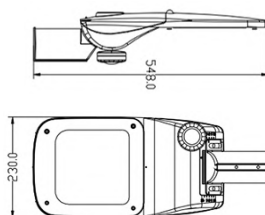

### Option



Photocell



light source*	lumen output (lm)	lumin. efficacy (lm/w)	light beam options
5000°K white			Type II
			Type III
LT-OS-100W	13000.0	130.0	Type IV
			Type IV Wide
			Type V Square Medium
			Type V Wide (Round)

3000/4000K CCT available on request

### Finish color options :

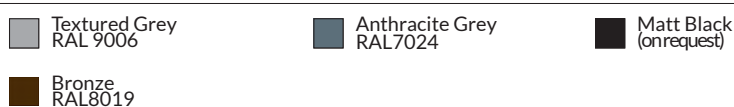

Customizable in different finishing colors

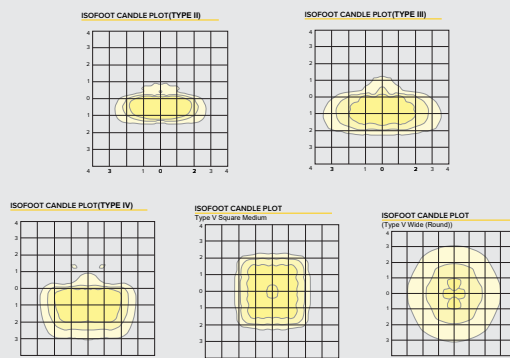





LI-TIAN LIGHTING

Technical features



Technical data

Wattage	150W
IP Rating	IP65
IK Rating	IK08
Material	High corrosion resistance die-cast copper-free aluminum body
Coating	Polyester powder coating with phosphochromating pre-finish
Light source	SMD high-intensity power LEDs
Standard Deviation Color Matching	:MacAdam step 3
Screws	Stainless steel
Transformer	Electronic power supply 220/240V 50/60Hz built-in or AC120-277V
Gasket	Silicone rubber
Glass	Tempered
Power cable	1 mt. neoprene power cable included
Gross weight	5.5 Kg
Surge Protection	6 KV/10KV
Notes	Can on request DALI version available on request



# LT-OS-150W

Die-cast aluminium body (EN 47100).  
 Double layer polyester powder paint resistant to corrosion and salt spray fog.  
 Silicone rubber gaskets.  
 AISI 316 stainless steel external screws.  
 Driver protected against voltage surges up to 10kV.  
 PMMA lenses for LEDs.  
 Screen made of 5mm thermal-shock resistant tempered glass.  
 High quality LED sources characterized according to IES TM-30, with high color consistency <3SDCM and long useful life >60000 hours at L80.

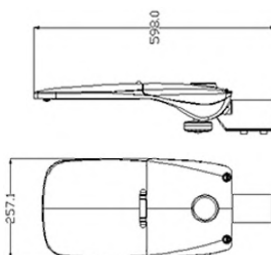

### Option



Photocell



light source*	lumen output (lm)	lumin. efficacy (lm/w)	light beam options
5000°K white			Type II
			Type III
LT-OS-150W	19500.0	130.0	Type IV
			Type IV Wide
			Type V Square Medium
			Type V Wide (Round)

3000/4000K CCT available on request

### Finish color options :



Customizable in different finishing colors

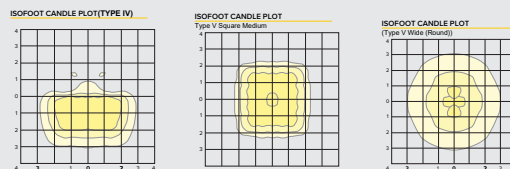
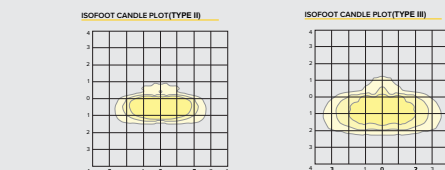



LI-TIAN LIGHTING

Technical features



Technical data

Wattage	200W
IP Rating	IP65
IK Rating	IK08
Material	High corrosion resistance die-cast copper-free aluminum body
Coating	Polyester powder coating with phosphochromating pre-finish
Light source	SMD high-intensity power LEDs
Standard Deviation Color Matching	:MacAdam step 3
Screws	Stainless steel
Transformer	Electronic power supply 220/240V 50/60Hz built-in or AC120-277V
Gasket	Silicone rubber
Glass	Tempered
Power cable	1 mt. neoprene power cable included
Gross weight	6.7 Kg
Surge Protection	6 KV/10KV
Notes	Can on request DALI version available on request



# LT-OS-200W

Die-cast aluminium body (EN 47100).  
 Double layer polyester powder paint resistant to corrosion and salt spray fog.  
 Silicone rubber gaskets.  
 AISI 316 stainless steel external screws.  
 Driver protected against voltage surges up to 10kV.  
 PMMA lenses for LEDs.  
 Screen made of 5mm thermal-shock resistant tempered glass.  
 High quality LED sources characterized according to IES TM-30, with high color consistency <3SDCM and long useful life >60000 hours at L80.

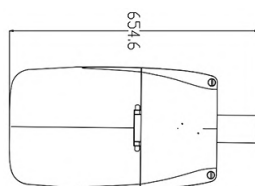

### Option

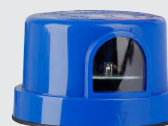

Photocell



light source*	lumen output (lm)	lumin. efficacy (lm/w)	light beam options
5000°K white			Type II
			Type III
LT-OS-200W	26000.0	130.0	Type IV
			Type IV Wide
			Type V Square Medium
			Type V Wide (Round)

3000/4000K CCT available on request

### Finish color options :



Customizable in different finishing colors

